

Sheepfol

13'x 26'x 8'(4x8x2.4m)







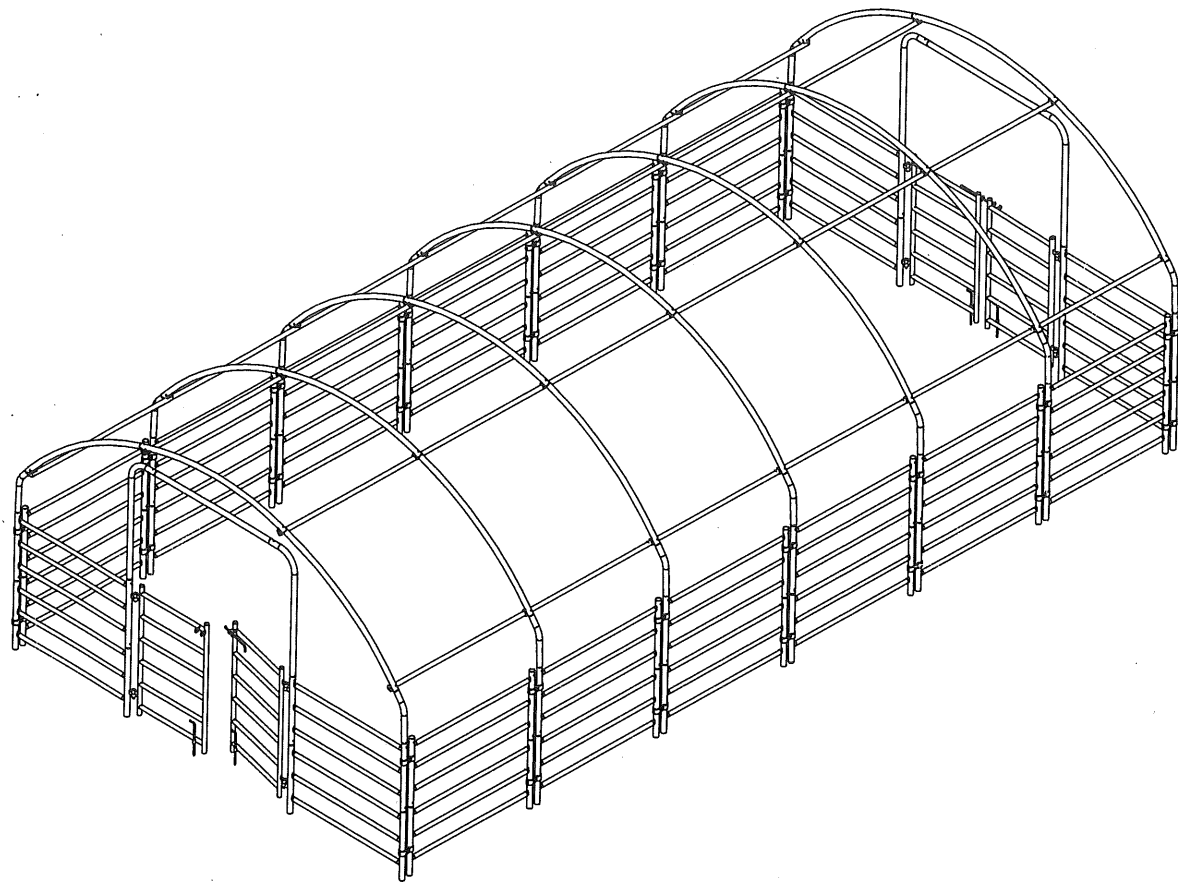

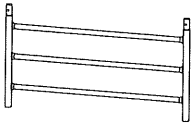

Weather Fast™

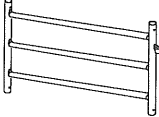

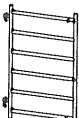

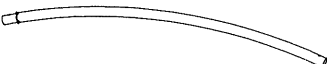
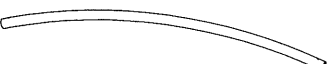

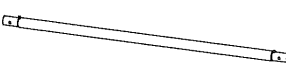

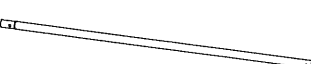
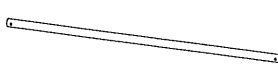

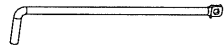
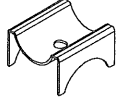

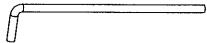
ASSEMBLY MANUAL

Model NO.:99016XL



Tools required for assembly (not included)

Item	Description	Drawingon	Quantityn
1	Side Panel-lower Part		12
2	Side Panel-upper Part		12
3	Door panel-upper Part		4
4	Door panel-lower Part		4
5	Door - Left		2
6	Door - Right		2
7	Bend Tube with Male End		14
8	Bend Tube		7
9	Corner Bend Tube		14
10	Top Tube for Door		2
11	Bend Tube for Door		4
12	Cross Rail Tube with Male End		20
13	Cross Rail Tube		4

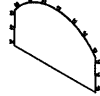
Item	Description	Drawingon	Quantityn
14	Door Bolt		2
15	Tube Connector		28
16	Clamp		56
17	Stake		4
18	Bolt M10x45		28
19	Bolt M8x55		54
20	Bolt M8x95		28
21	Lock Nut M8		82
22	Lock Nut M10		28
23	Ratchet Tie Down		4
24	Rope		2
25	Pin		4
26	Cover		1
27	Back Panel		1

Connect part #1 & #2 together with fittings #19 & #21 to get 6 part A.
 Connect part #3 & #4 together with fittings #19 & #21 to get 4 part B.

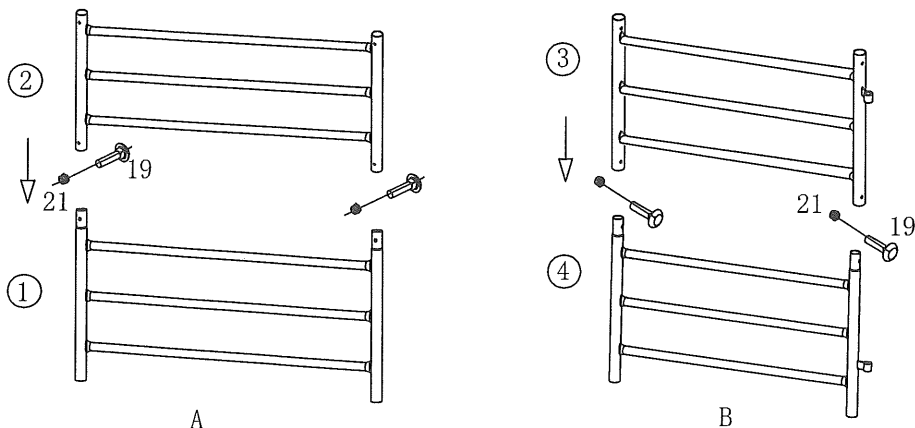

Connect parts A & parts B and doors #5 & #6 with fittings #16, #18 & #22 as shown below.
 Note: When connect A & B together, please place them on the same straight line.

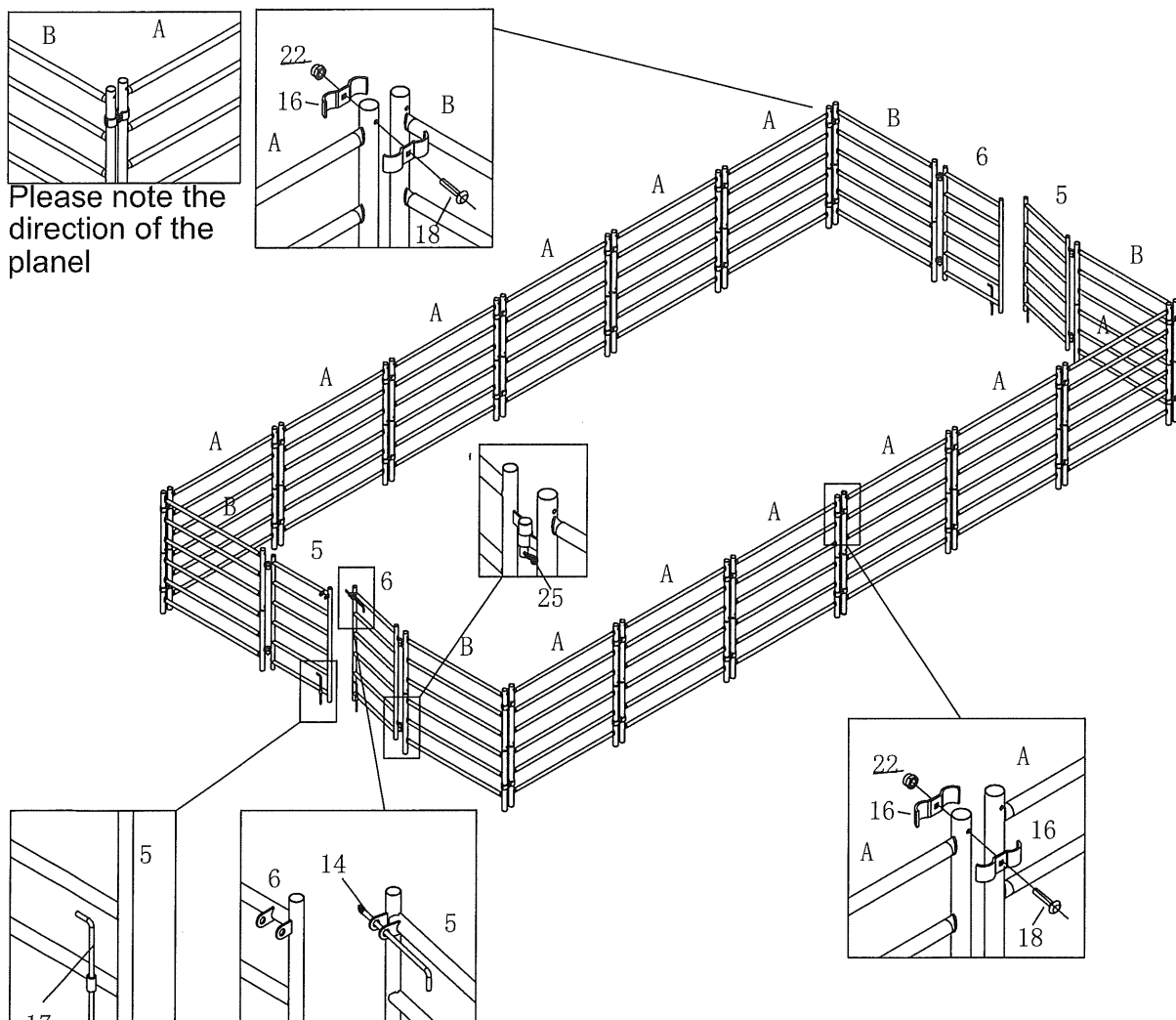

Connect part #10 & #11 together with fittings #19 & #21 as shown below to get the door support.
There are two door support intotal

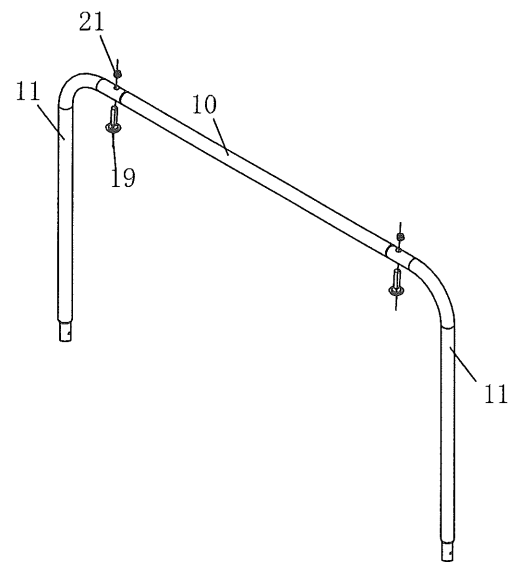

Assemble the door support above the door and secure with fittings #19 & #21.

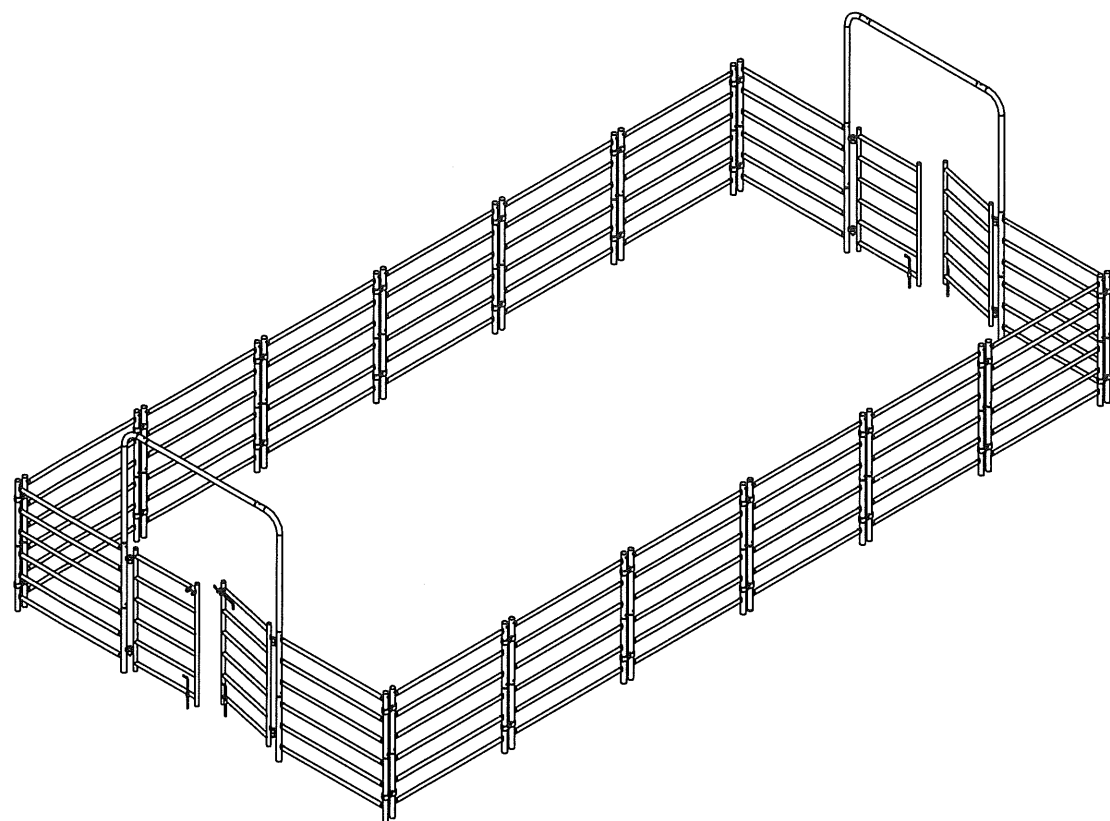

Connect parts #7 #8 & #9 together and secure with fittings #20. Do not screw the lock nuts.

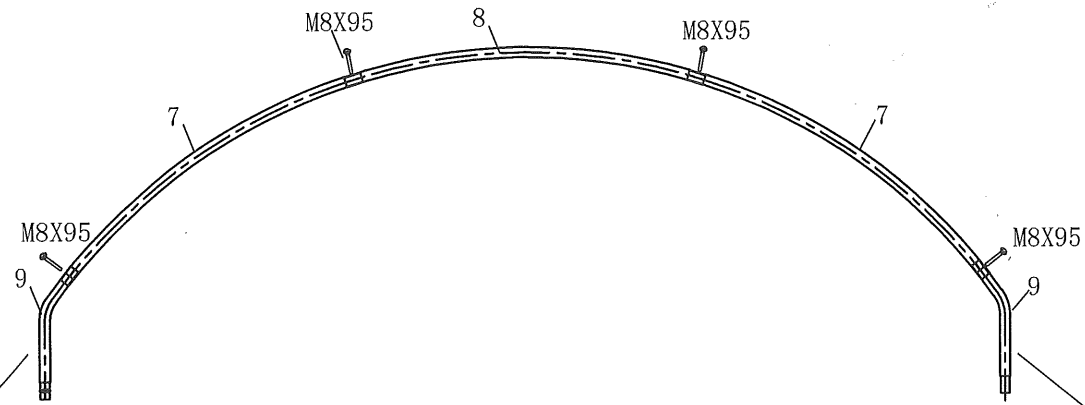

Note: The short end of part #9 should be connected to part #7.

Note: The short end of part #9 should be connected to part #7.

Insert the assembled cover support into the right post poles as shown below and then secure with fittings #19 & #21.

Note: The end supports should be inserted to the post pole of part B.

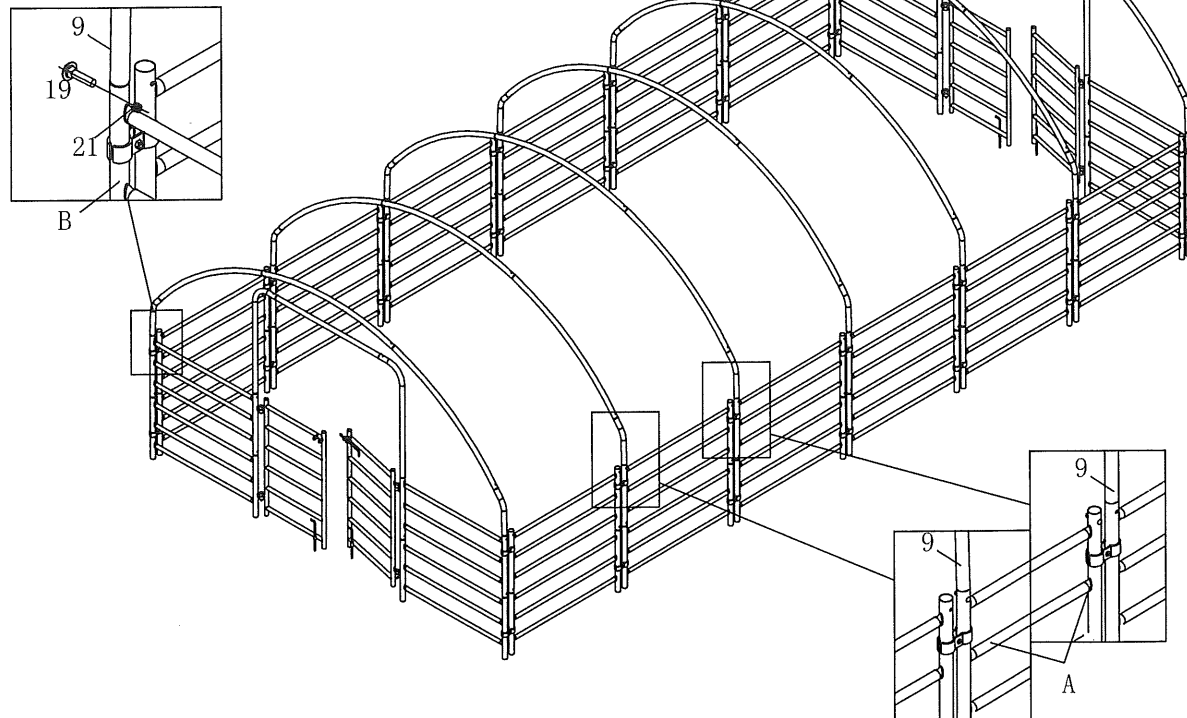

Note: The middle supports should be inserted to the middle

Connect five parts #12 and one part #13 together as shown below to get the 3 cross rails. And then assemble the cross rails to the bent support with tube connectors #15 and fittings #20 & #21.

Lay out the roof frame parts as shown below.

Begin with the rare panel, put the rare panel to its position as shown below. Attach the panel to the frame tube with the velcros sewed on the panel.

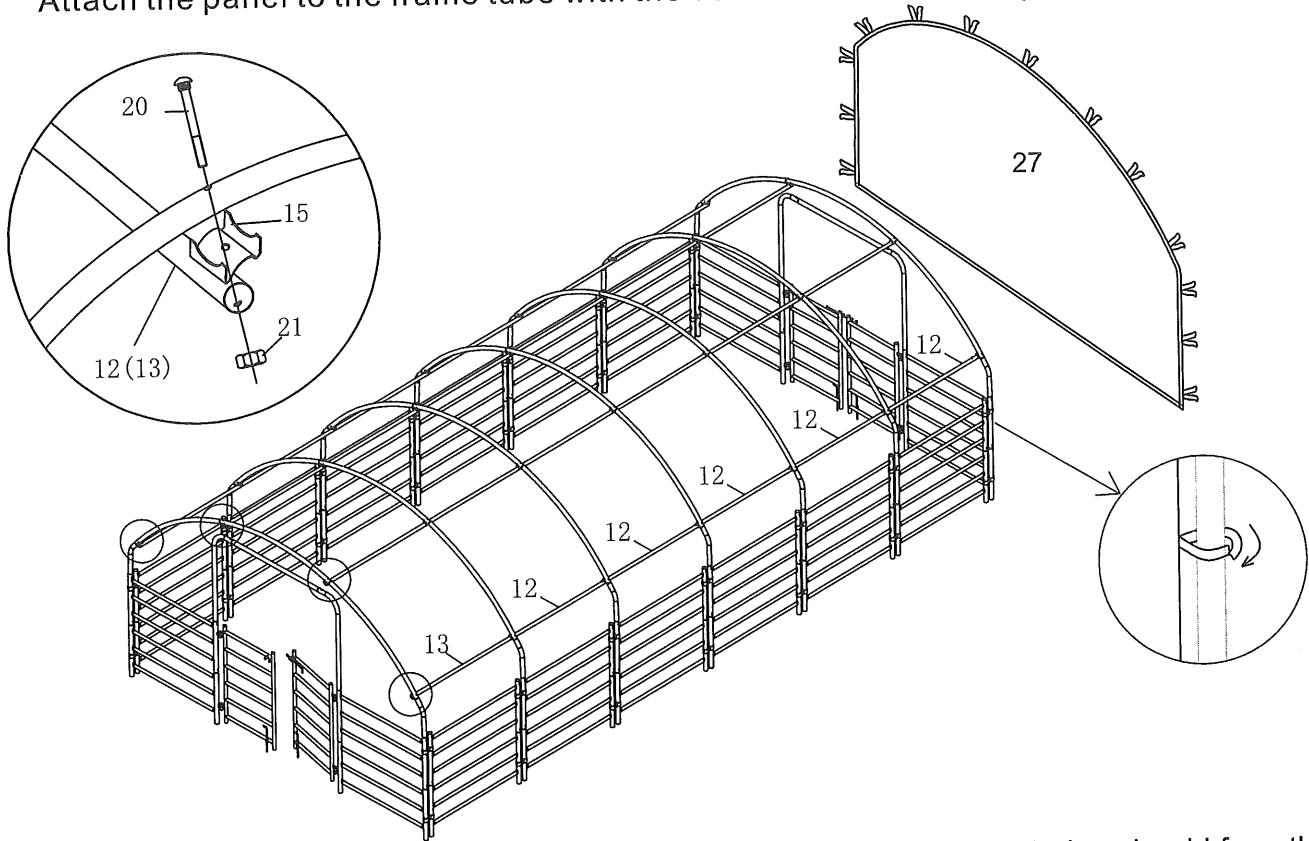

Unfold the cover and pull it cover the frame .Note that the side with out holes should face the side with door panels. Secure the four corners to the frame with ratchet tie downs and tighten the side of the cover to the frame by ropes as shown below.

