

ADDITIONAL ANCHORING

#99008/#99015



#99047



#99009



#99016



Additional Anchoring Included: We understand that some areas are more prone to high winds than others, which is why we include additional anchorage for your Shelter.

4 heavy duty ground stakes and 4 complete ratchet systems are included to help keep your shelter firmly in place, but we advise dismantling your shelter if severe weather is anticipated.



ROUND ROOF SHELTER

12' x 24' x 8'(3.6 x 7.3 x 2.4 m)

ASSEMBLY MANUAL

Model No. 99015



Tools required for assembly (not included)



Please read instructions fully before beginning assembly!

V.1.

TABLE OF CONTENTS

Important safety instructions	2
Intended use	2
Parts list	3-4
Assembly preparation	4-5
Assembly	5 - 11
Maintenance and care	12
Limited warranty	12

IMPORTANT SAFETY INSTRUCTIONS



WARNING!

- To reduce the risk of serious injury, read the following safety instructions before assembling and using the product.
- No responsibility is accepted for damages or injuries resulting from improper installation or noncompliance with these instructions.

• Please note that the Manufacturer has no control over the elements such as wind, heavy snow or rain. The Manufacturer cannot control the location or soil conditions into which the shed is placed. The Manufacturer, without control of the elements, location or soil conditions, cannot be held responsible for damages caused by the shed to other items or damages to the shed itself.

- This product is a temporary structure and is not recommended as a permanent structure.
- Choose your shed's location carefully. Install your shed on flat horizontal ground only.
- Ensure enough clearance around the product. Before assembling the product, find level ground not less than 6' (1.8 m) away from any structures or obstructions, such as fences, garages, houses, etc.
- Check for overhead utility lines, branches, laundry lines, etc. Do not install near roofs or other structures that may shed snow, ice or excessive run-off onto your shed. Keep away from electrical wires!
- Check municipal by-laws before setting up the product.
- Get an overview of all parts before attempting installation. Make sure all components are present.
- Do not use this product in environments for which it is not intended (i.e. extreme cold, high winds, extreme heat, heavy rainfall, etc.).
- Always wear safety glasses when assembling this product. Wear gloves when working with tubing to prevent cuts or abrasions.
- Any assembly or maintenance on the product must be carried out by adults only.
- Make sure you have the necessary manpower when assembling or moving the product.
- Keep children and pets away while setting up the product.
- CAUTION! Always keep children under close supervision while they are using this product or are in its vicinity. Never leave children unattended.
- CAUTION! Anchors must be used with all sheds. Covers should not be installed on any product until it has been properly anchored to the ground.
- Proper anchoring, keeping the cover tight and free of snow and debris is the responsibility of the consumer. Damages caused by improper anchoring are not included in the warranty.
- WARNING! Keep all flames and heat sources away from this fabric shed. The fabric will burn if left in continuous contact with a flame source.
- Do not use product with open flames and heated elements inside or near the product, including all types of stoves, gas heaters, gas lanterns, citronella torches, mosquito coils, etc.
- WARNING! In order to reduce risk of burning and avoid damage, DO NOT
 - cook, smoke, refuel or use any open flame devices in or around the shed.
 - store flammable liquids (gasoline, kerosene, propane, etc.) in the shed.
 - operate gas-powered vehicles/equipment in or around the shed.
- Keep open flames a safe distance away from the shed.
- Do not use hard-edged tools or instruments, such as rakes or shovels, to remove snow. These may puncture the cover.
- NEVER start the engine of any vehicle or machine inside a closed shed. Ensure good ventilation when starting engines and when doing any work with paints, cleaning agents, etc.
- This shed is NOT meant to hold heavy snow or ice loads. Snow or ice accumulation may cause your shed to collapse. To avoid overload, brush snow and ice from the roof with a broom or mop.
- NEVER clear the roof of snow or debris from inside the shed to avoid collapse, damage to property, personal injury and/or death.
- Remove accumulated water from the roof immediately or disassemble the shed in order to avoid any damage.



- Do not use alkaline detergents for cleaning. It will damage the polycarbonate material. Soap and warm water are recommended.

**IMPORTANT! READ CAREFULLY AND RETAIN
FOR FUTURE REFERENCE**

INTENDED USE

This temporary shed is intended to offer protection from damages caused by the sun, light rain, light snow, tree sap, bird and animal excrements. Do not use it to shield goods from high winds, heavy snow or ice storms. Only use it for its intended use.













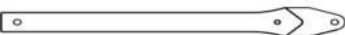

ASSEMBLY

Please read instructions fully before beginning assembly.

Step 1: Checking the Parts

Unpack and check the contents of the box. Make sure that you have all the parts described in the parts list shown hereafter.

PARTS LIST

Part#	Description	Drawing	Qty and individual length
1	Roof Tube		7* (1090mm)
2	Roof Tube w/Male End		21* (1095mm)
3	Vertical Tube for 4 Corner Legs		4* (68.5mm)
4	Vertical Tube for Center Legs		10* (128.2mm)
5	Cross Rail Tube		5* (1245mm)
6	Corner Bent Leg		4* (635mm)
7	Cross Rail Tube (with male end)		25* (1270mm)
8	Support Brace (1st half)		4* (850mm)
9	Support Brace (2nd half)		4* (550mm)
10	Ratchet Tie Down		4
11	Tube Connector		35
12	Foot Plate		10
13	Pin Bolt		10
14	Cotter Pin		10
15	M8 Nut		53









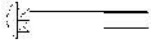

16	M8 Washer		53
17	M8X90 Bolt		35
18	M8X55 Bolt		18
19	M6X35 Bolt		4
20	Roof Tarp		1
21	M6 Nut		4
22	M6 Washer		4
23	15" Auger Anchor		4
24	Cable 1'-Length		4
25	Cable Clamp		4
26	Rope		2
#	Owner's Manual		1

Diagram A below represents the completed Frame Assembly once steps 1-6 are completed.

Note: 4 or more people are required for safe and accurate assembly.

Diagram A

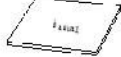
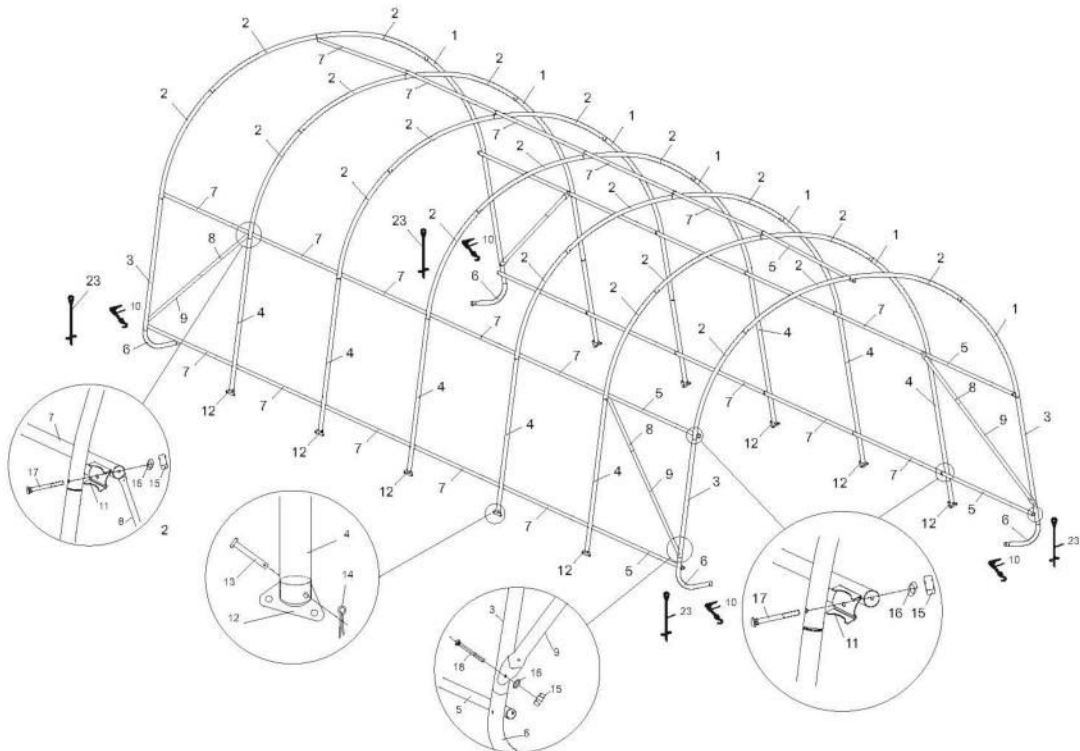

Step 2: Frame Assembly

Select level and suitable location for your shelter.

1. Assemble the two End Ribs
 - a. Follow **Diagram B** connecting the 8 tubes together (1pc tube #1, 3pcs tube #2, 2pcs tube #3 & 2pcs Bent Legs #6) to form 1 End Rib.

Note: Tighten the connection B2&B3 by fittings (#15,#16,#18). But do not tighten B1 now. B1 connection uses fitting(#15,#16,#17).

- b. Repeat it to get the other End Rib.

Diagram B

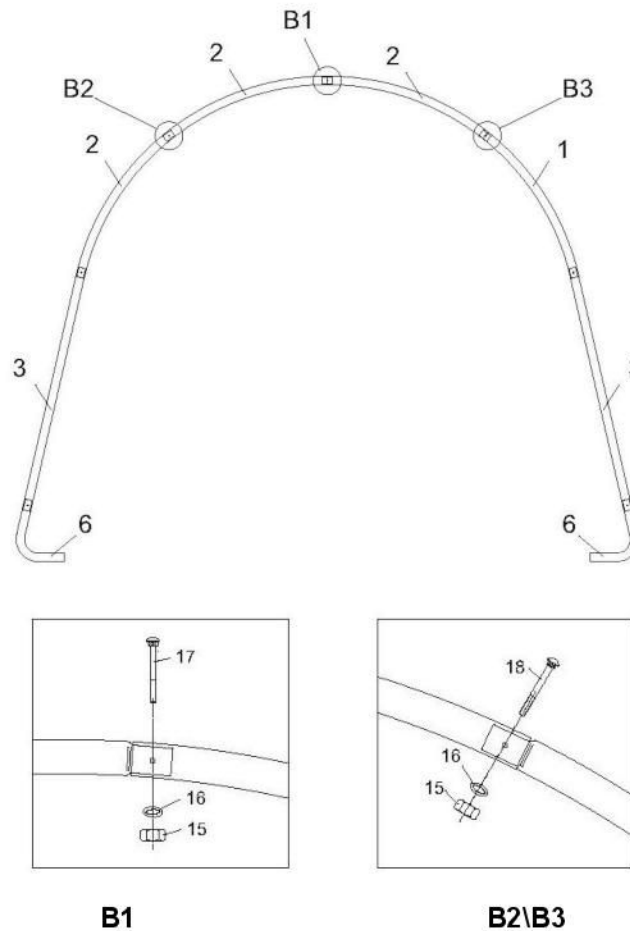

2. Assemble the 5 Center Ribs
 - a. Follow **Diagram C** connecting these 6 tubes together (1pc tube #1, 3pcs tube #2, 2pcs tube #4) to form one Center Rib.
 - b. Repeat it to get the other 4 Center Ribs.
 - c. Insert the Center Ribs into the Foot Plate (#12). Align holes in the pole and foot plate, push the Pin Bolt (#13) through all the holes, Insert the Cotter Pin (#14) and split the tongues of the cotter pin with a slot screwdriver to secure this connection.

Note: Tighten the connection C2 & C3 by fittings(#15,#16,#18). But do not tighten C1 now. C1 connection uses fitting(#15,#16,#18)

Diagram C

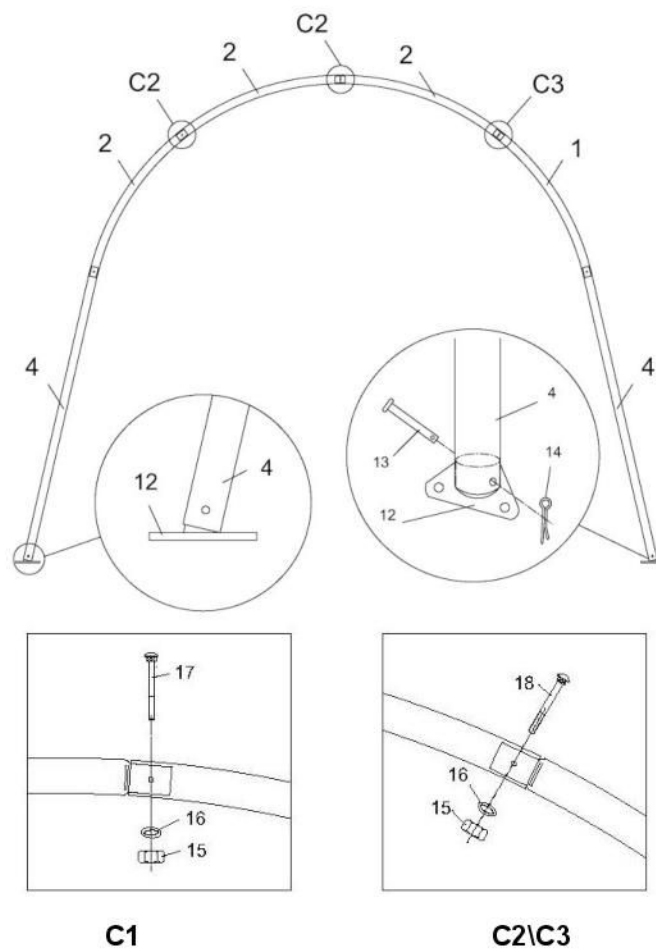

Use a rubber or wooden mallet to ensure all pipes are fully inserted.

3. Attach Side Cross Rails

- a. Pick one End Ribs & 5 Tube #5. Follow Diagram D use part #11 connecting Tube #5 and the End Rib by fittings (#15, #16 & #17) on connection D1, D2, D3, D4

Note: Top connecting B1 does not need parts #11. Just disassemble previous connection and add tube #5 and retighten B1 connection.

Diagram D

- b. Insert the male end of tube #7 into tube #5. See Diagram E
- c. Connect the two parts of Support Brace (#8 & #9) by Fittings (#15, #16 & #19).
- d. Take one Center Rib and put it just stand on end of tube #5. Fix one end of the Support Brace (#8) with Tube #5, #7 and Tube #4(on Center Rib) by fittings (#15, #16 & #17).And then fix the other end of Support Brace (#9) with Tube #3 and Tube #6 (on End Rib) by fittings (#15, #16,#18).
- e. Same way to assemble the other side brace.

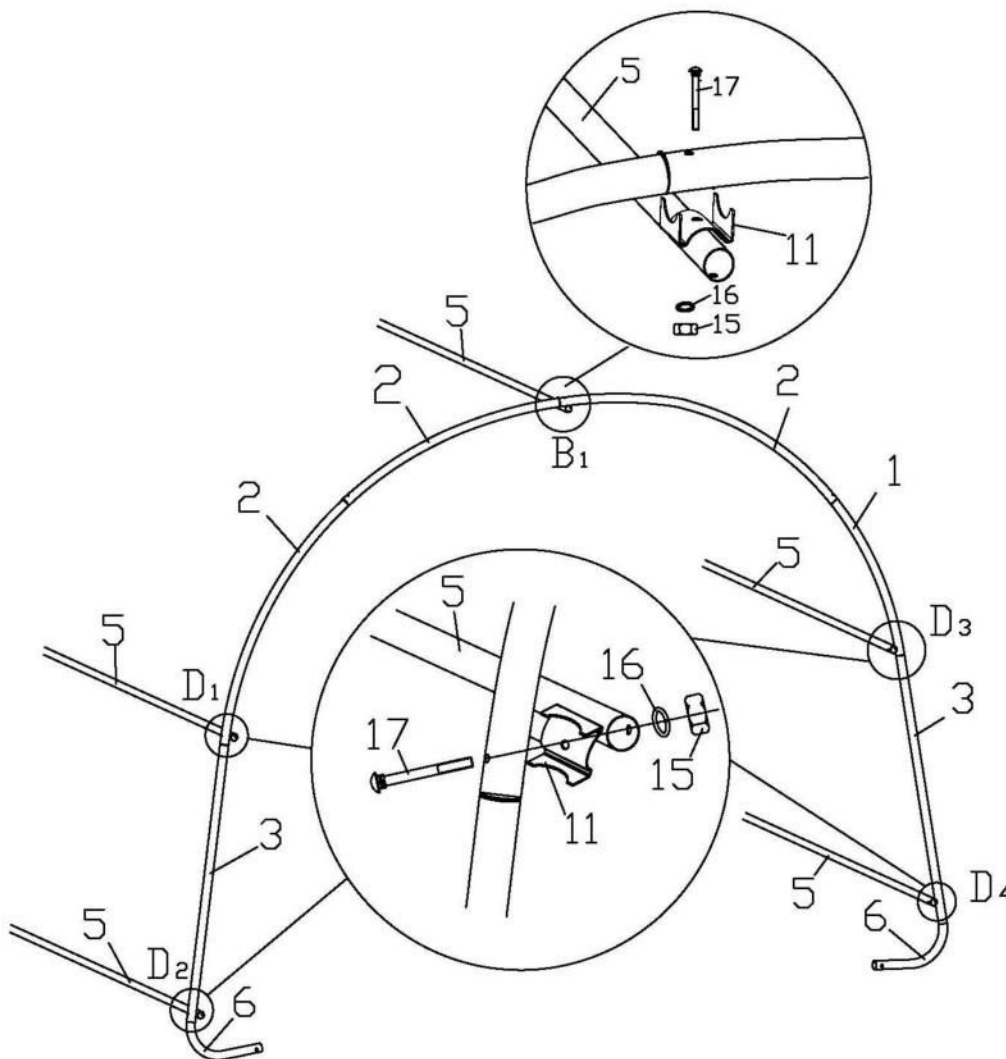
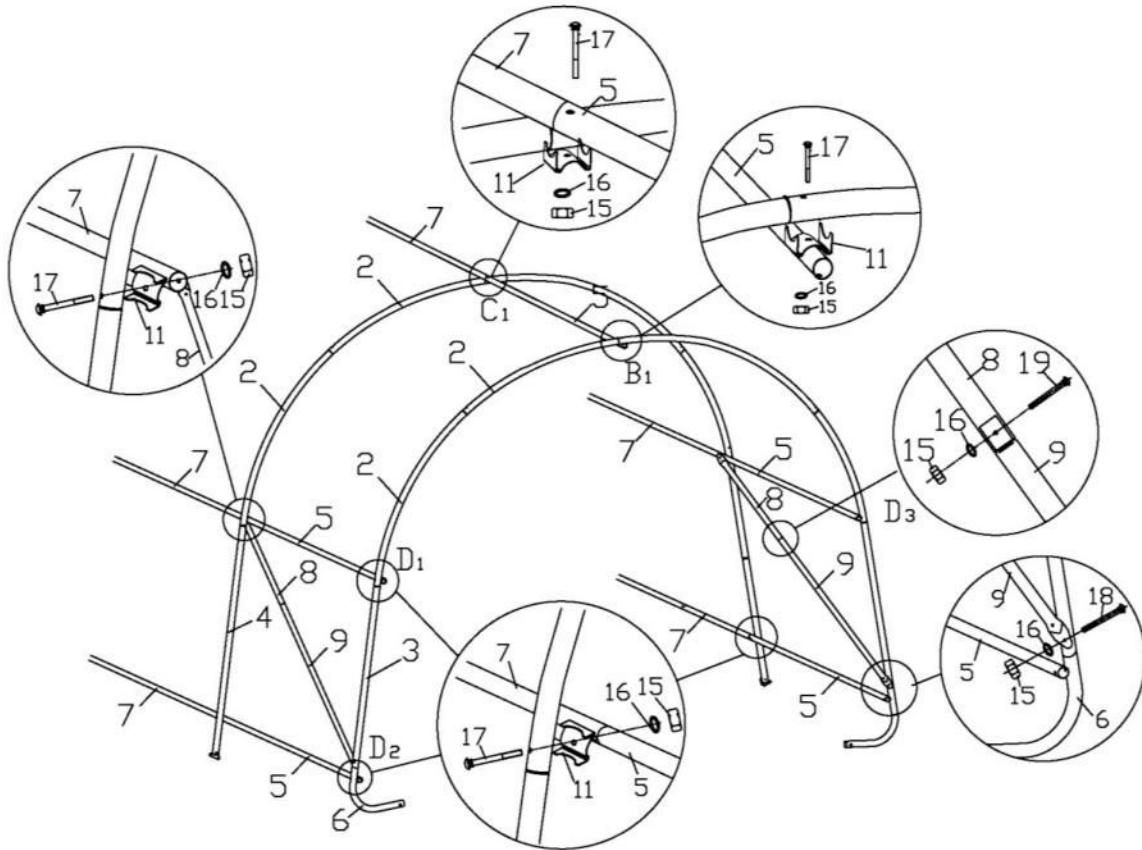

Diagram E



- f. Repeat above steps, connecting all the rest 3 Center Ribs and last end Ribs, you will get the whole frame finished as Diagram F

Note: The other set of Support Brace needs to be assembled in an opposite way with the 1st set.

4. Square and Anchor the Frame

- Check the measure of frame both 12' at the front and back corners, as well as the center.
- Take a diagonal measure as shown in **Diagram F**. When these two measures are equal the frame is square. Adjust the frame until they are equal to within 1".
- Check the width measures again to ensure all are equal at 12'.

Diagram F

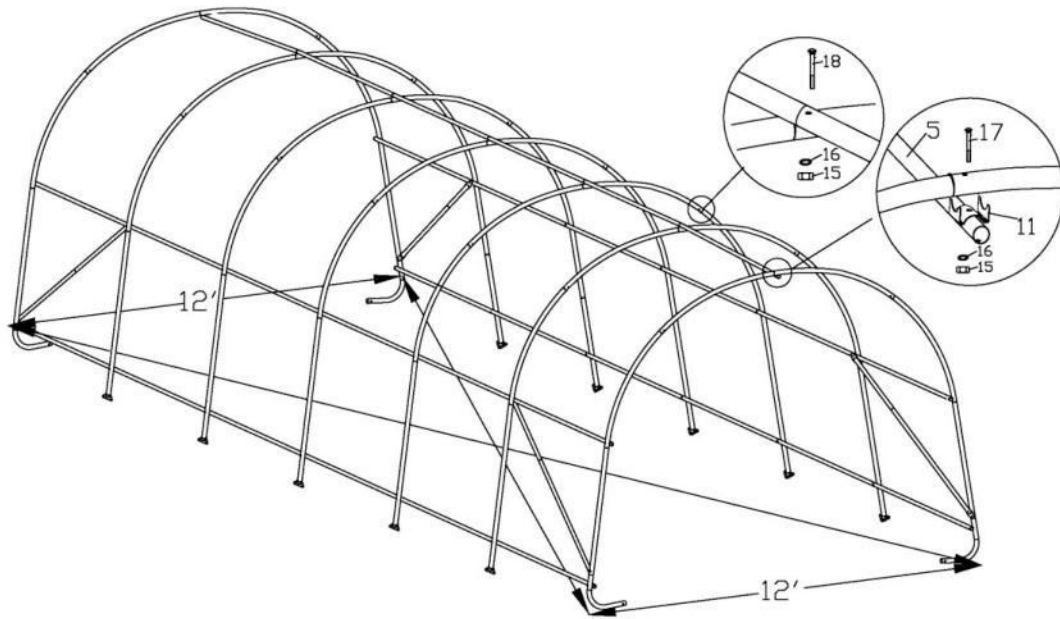

5. Square and Anchor the Frame

- d. Next, install Anchors (Part #23, #24 & #25) at the 4 Corner bent legs by screwing the removable anchor (#23) into the ground and to the inside of the shelter. Secure with cable (#24) and cable clamp (#25) as shown in Diagram G.

Diagram G

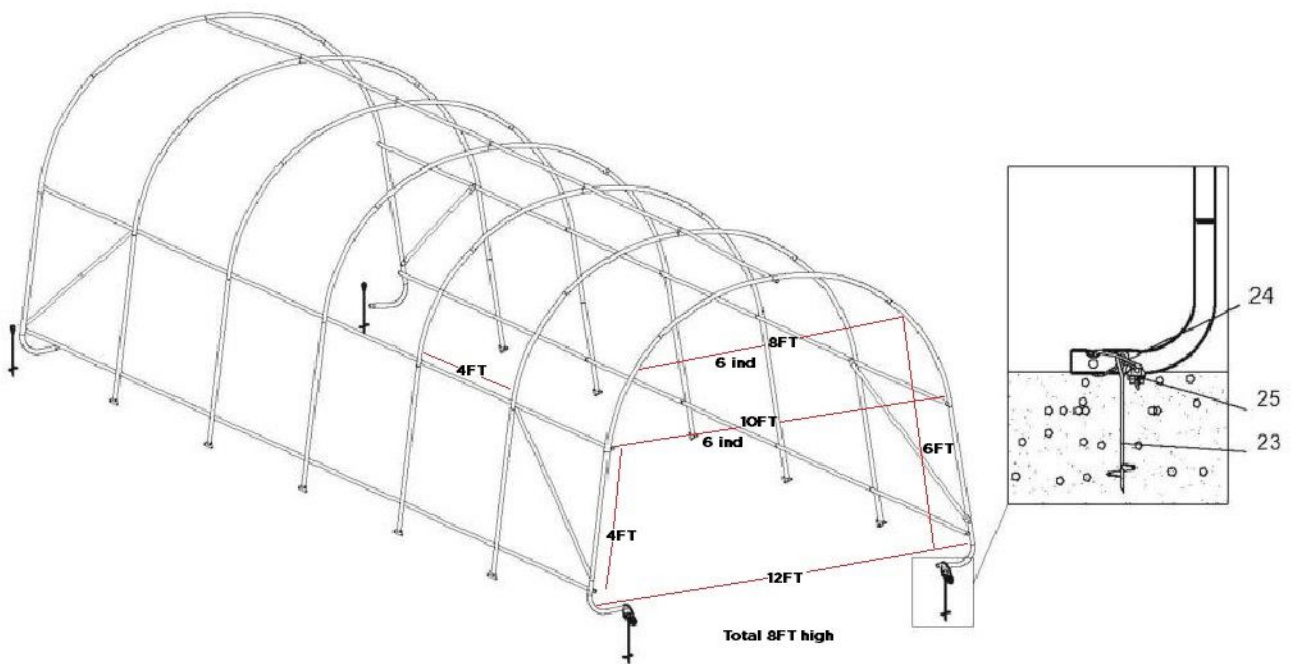

Step 3

Installing the Main Cover

- a. Lay the cover on the ground next to the frame with inside of the cover (the side with eyelets) facing down and the webbing on the front and rear of the corner of the building. **See Diagram I.**
- b. Assemble the ratchets (Part #26) to the web ends on the 4 corner of the cover, 1pc for each corner.
- c. Tie a rope to the eyelets of the cover, each side one rope. (If you have enough people to work together, suggest you add another rope in the middle).
- d. Pull cover over the frame by the help of the rope as **Diagram J**, making sure to center cover on frame. There should be an equal amount of overhanging at all four corners. **See Diagram I.**

Diagram I

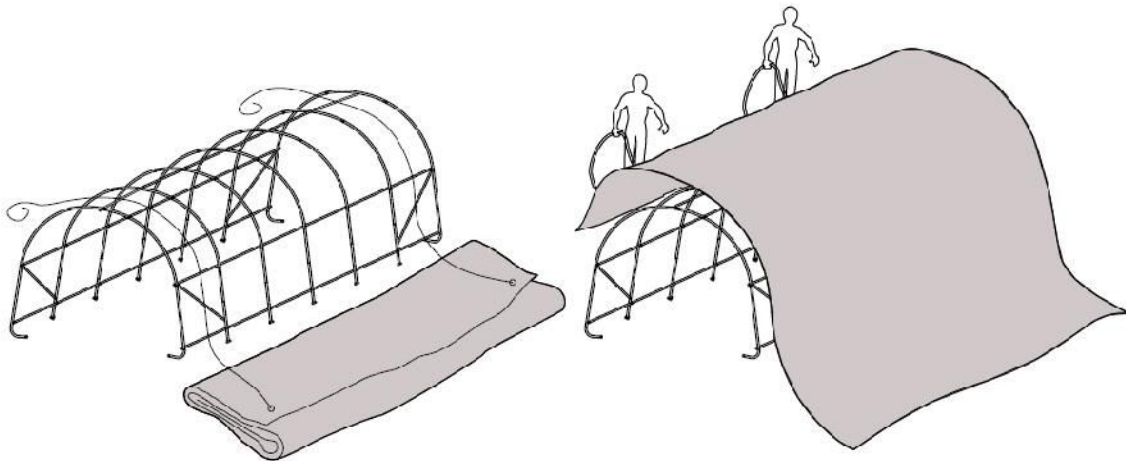

- e. Insert the “S”- hook on ratchet into hole on the Bent Corner Leg. Wind the ratchet so that the webbing overlaps itself. Do not over tighten.
- f. Follow below **Diagram J**, use Rope(#26) lacing the Cover with the bottom Cross Rails through the eyelets on the Cover bottom part. Make sure the Cover is even in front & back, also even in the 2 sides. Lacing the Cover tight on the frame.

Diagram J

NOTE: Over-tightening can cause damage to straps and/or the anchor point. DO NOT over-tighten!

The shelter is now ready for use.

Note: Please check periodically (two to three times in the first week – weekly for the balance of the first month of set up) and tighten ratchet tie-downs and all hardware as needed. Monthly inspection is recommended throughout usage.

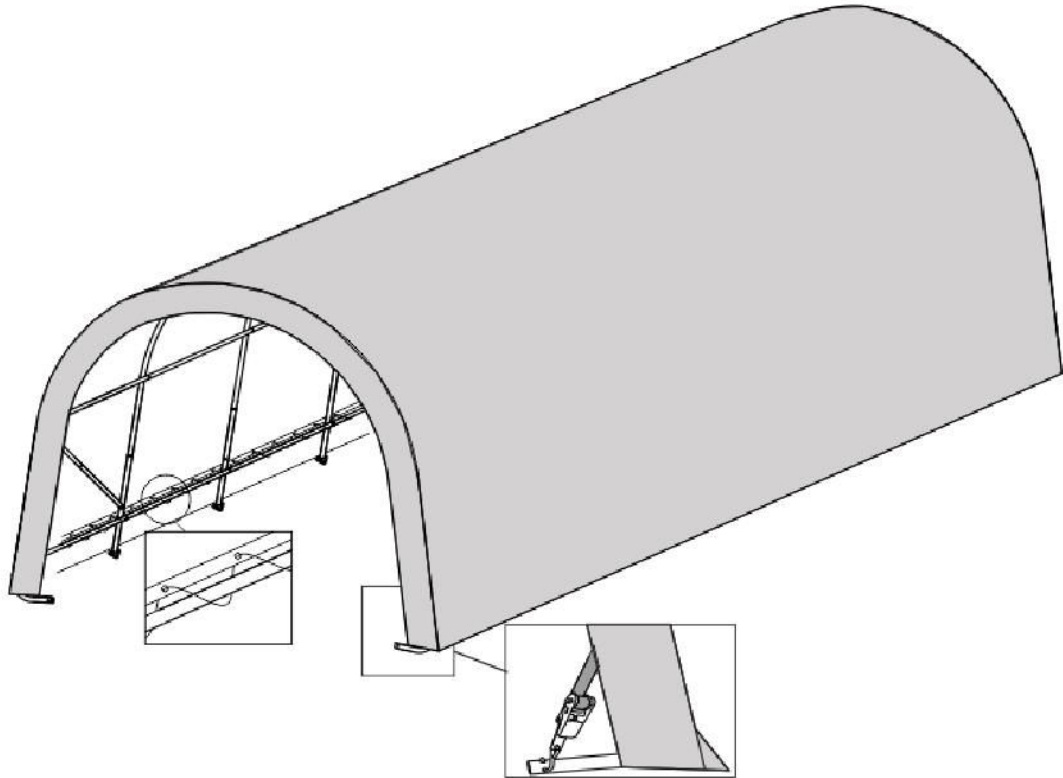

Disassembly

When disassembling the shelter, depress the spring-loaded bar and open ratchet handle completely to allow the webbed belt to disengage the ratchet.

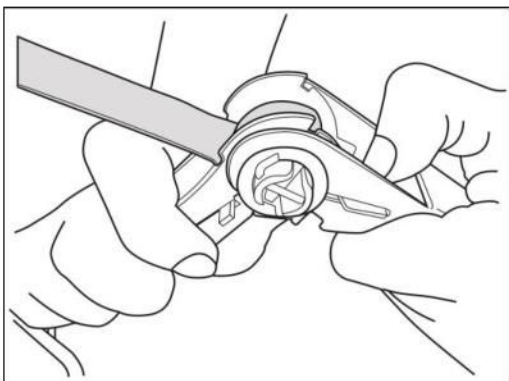

PLEASE RE-READ ALL WARNINGS CONTAINED ON PAGE 2 OF THESE INSTRUCTIONS. SAVE THESE INSTRUCTIONS FOR FUTURE USE.

To dismantle, execute all instructions in reverse order.

Store your shelter in a cool, dry location between seasons to prolong usable life of all components. Components are not equally durable and will require replacement over time at differing intervals.