

SENTINEL CHICKEN COOP ASSEMBLY MANUAL

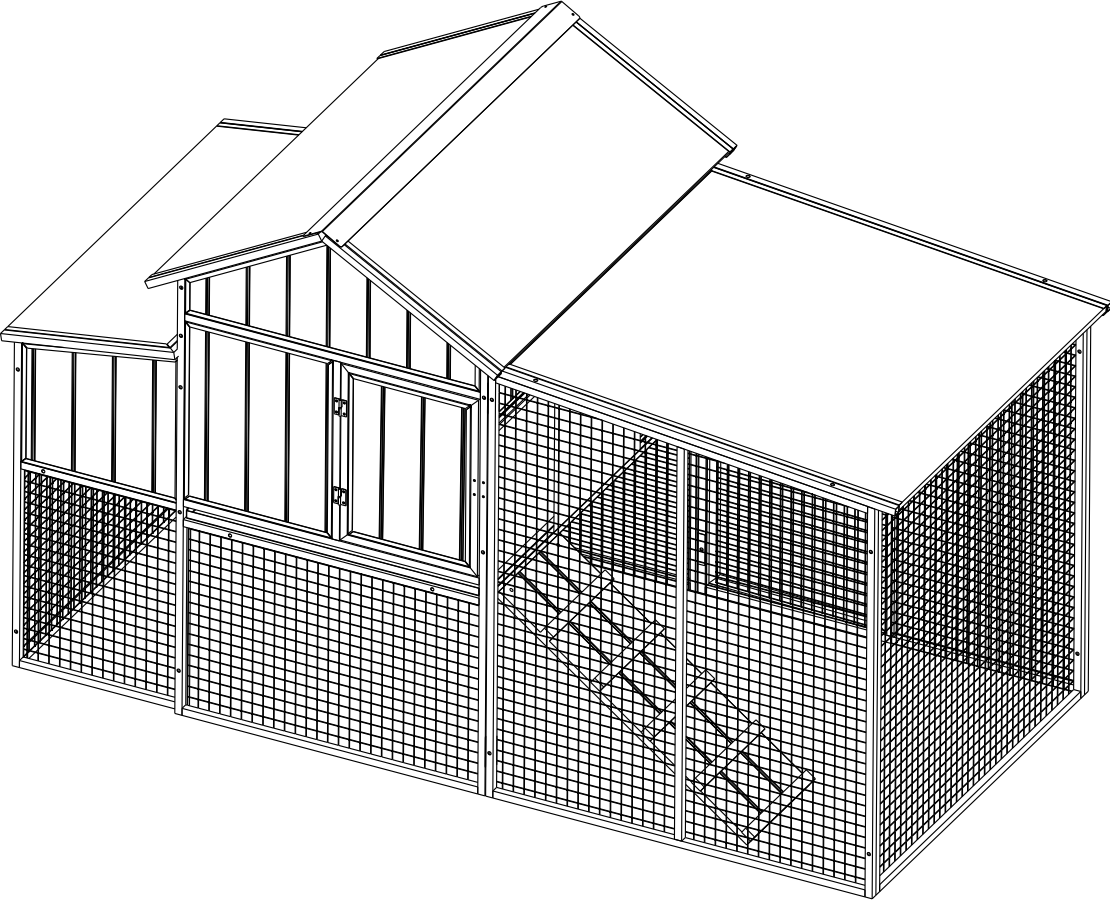

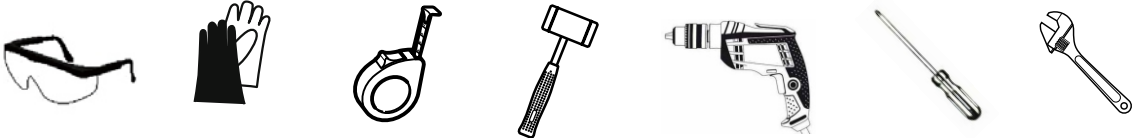



#99089



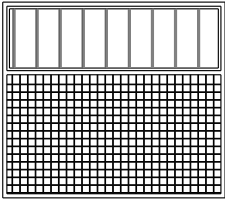
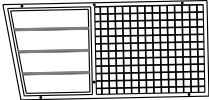
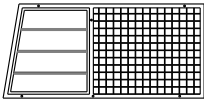
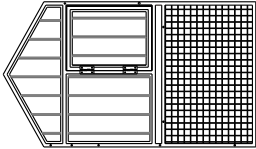
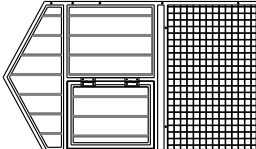
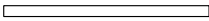
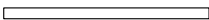
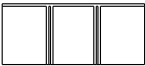

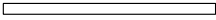

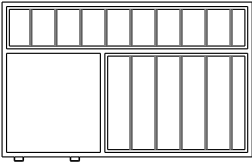



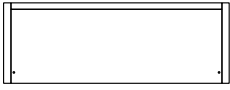

Tools required for assembly (not included)

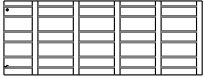
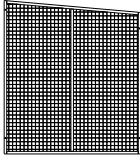
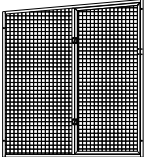
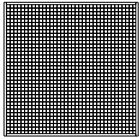
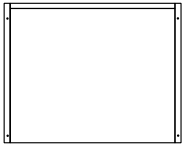

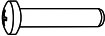
PARTS LIST

| Part# | Description | Drawing | Qty. |
|--------------|--------------------------------|---|-------------|
| 1 | Nesting Box Back Panel |  | 1 |
| 2 | Nesting Box Left Panel |  | 1 |
| 3 | Nesting Box Right Panel |  | 1 |
| 4 | Coop Roosting Area Left Panel |  | 1 |
| 5 | Coop Roosting Area Right Panel |  | 1 |
| 6 | Nesting Box Support Bar |  | 2 |
| 7 | Tray Support Bar |  | 2 |
| 8 | Nesting Box Floor |  | 1 |
| 9 | Nesting Box Divider |  | 2 |
| 10 | Clean-out Tray |  | 1 |
| 11 | Roosting Bar |  | 1 |
| 12 | Coop Roosting Area Back Panel |  | 1 |
| 13 | Coop Roosting Area Front Panel |  | 1 |
| 14 | Sliding Door |  | 1 |

PARTS LIST

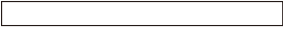
| Part# | Description | Drawing | Qty. |
|--------------|----------------------------|---|-------------|
| 15 | Nesting Box Roof |  | 1 |
| 16 | Coop Roosting Area Roof |  | 2 |
| 17 | Roof Cap |  | 1 |
| 18 | Ramp Hook |  | 2 |
| 19 | Ramp |  | 1 |
| 20 | Pen Left Panel |  | 1 |
| 21 | Pen right Panel |  | 1 |
| 22 | Pen front Panel |  | 1 |
| 23 | Pen Roof Panel |  | 1 |
| 24 | Lock |  | 1 |
| 25 | M6x45 Bolt |  | 10 |
| 26 | M6x30 Bolt |  | 32 |
| 27 | M6 Lock Nut |  | 14+1 |
| 28 | Self- Tapping Screw 3.5x13 |  | 8+1 |
| 29 | Tapping Screw 3.5x13 |  | 9+1 |
| 30 | Tapping Screw 2.9x9.5 |  | 4+1 |
| 31 | PVC Cover |  | 1 |

ASSEMBLY

Step 1

- Connect nesting box Back and Left Panels (#1 & #2) with M6x30 Bolt (#26).
Make sure the bottom of each panel is aligned properly.

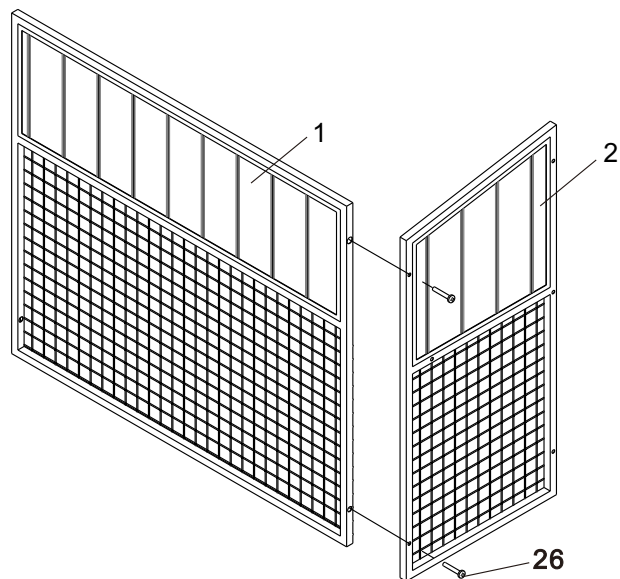

Step 2

- Connect nesting box Right Panel (#3) to the other side of above structure with M6x30 Bolt (#26).

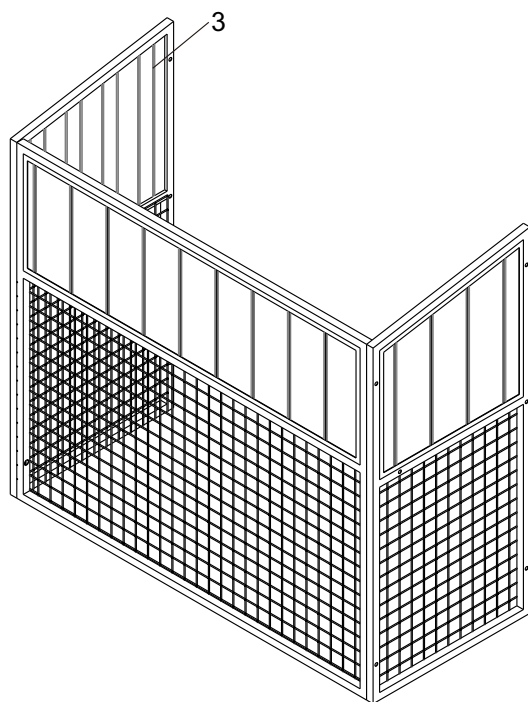

Step 3

- Attach the Coop Left Panel (#4) as below diagram with M6x45 Bolt (#25) and M6 Nut (#27).

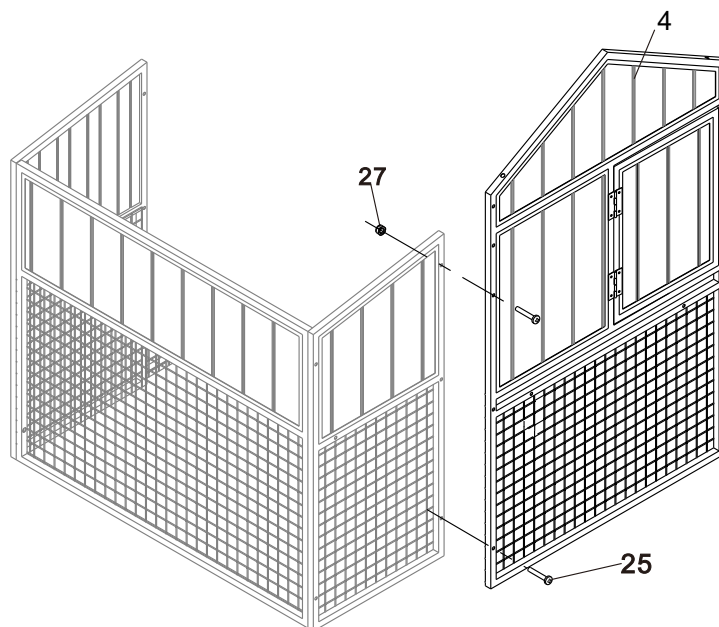

Step 4

- Same as Step 3, fix the Coop Right Panel (#5) to the frame.

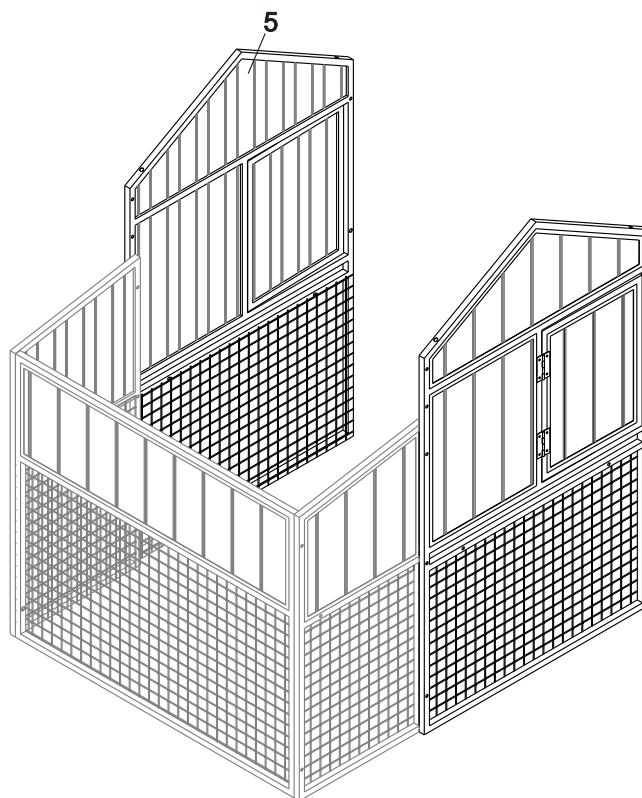

Step 5

- Fix the 2pcs Nesting Box Support Bar (#6) and 2pcs Clean Tray Support Bar (#7) as below diagram, with M6x45 Bolt (#25) and M6x30 Bolt (#26).

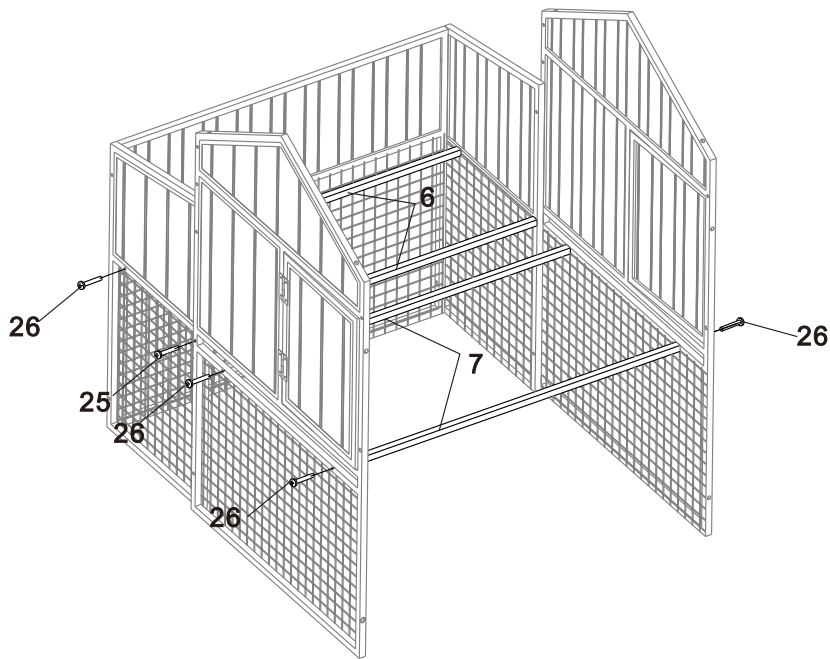

Step 6

- Put the Nesting Box Floor (#8) on top of Bar (#6), and then insert the two Nesting Box Divider (#9) as the diagram.

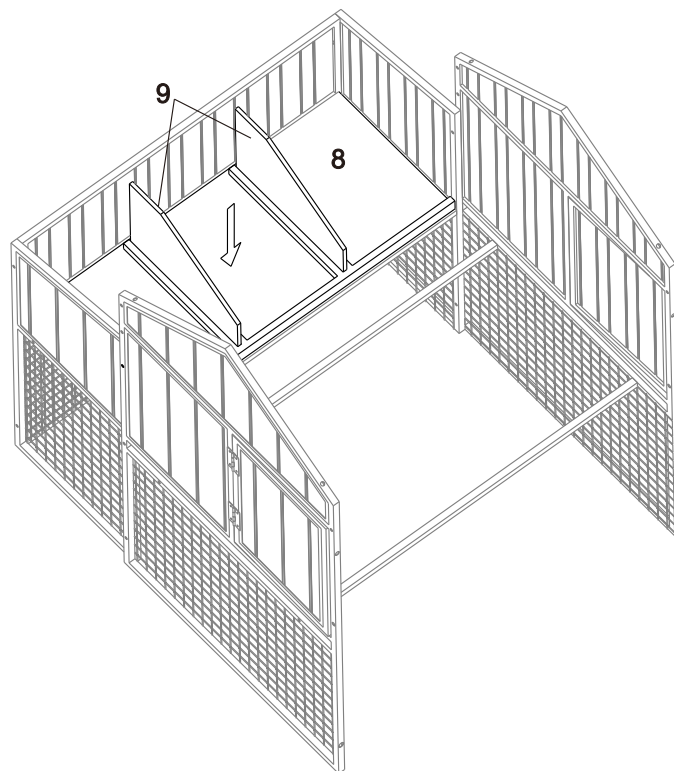

Step 7

- Insert the Clean-out Tray (#10) through the slot on the Right Panel of the Coop.
Place the Roosting Bar (#11) in the position as shown.

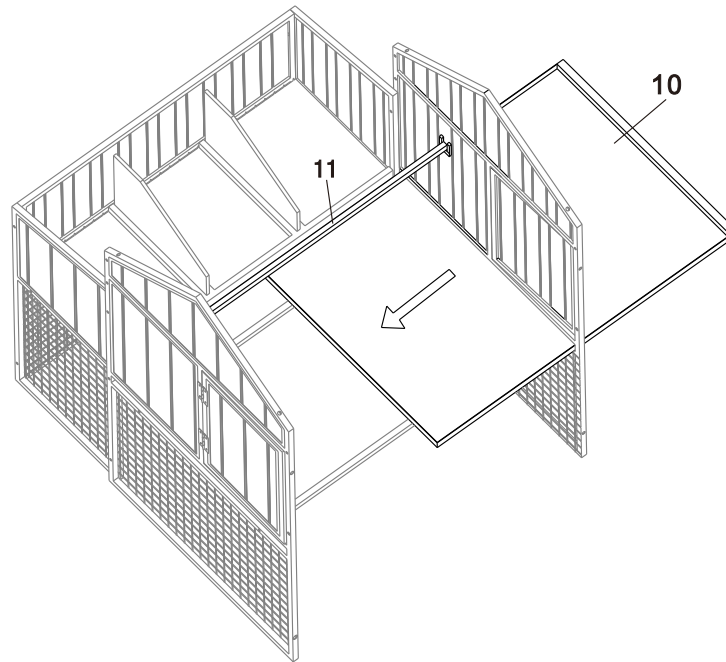

Step 8

- Assemble the Coop Back Panel (#12) with M6x30 bolt (#26).
- Note: Keep these 4 screws LOOSE tight for now. Tight them after the Nesting Area Roof assembled.

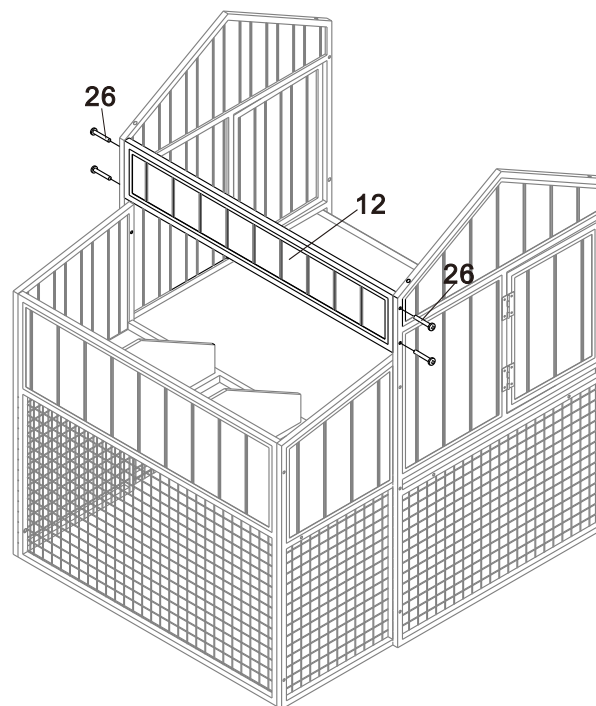

Step 9

- Insert the Sliding Door (#14) into the Coop Front Panel (#13).

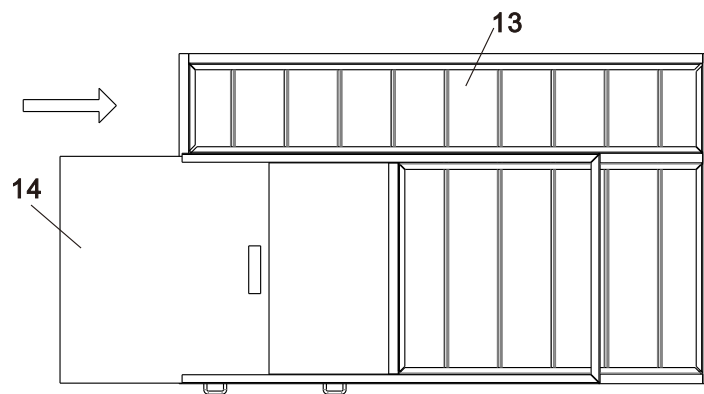

Step 10

- Then assemble the Coop Front Panel (#13) with M6x30 Bolt (#26) as below diagram.

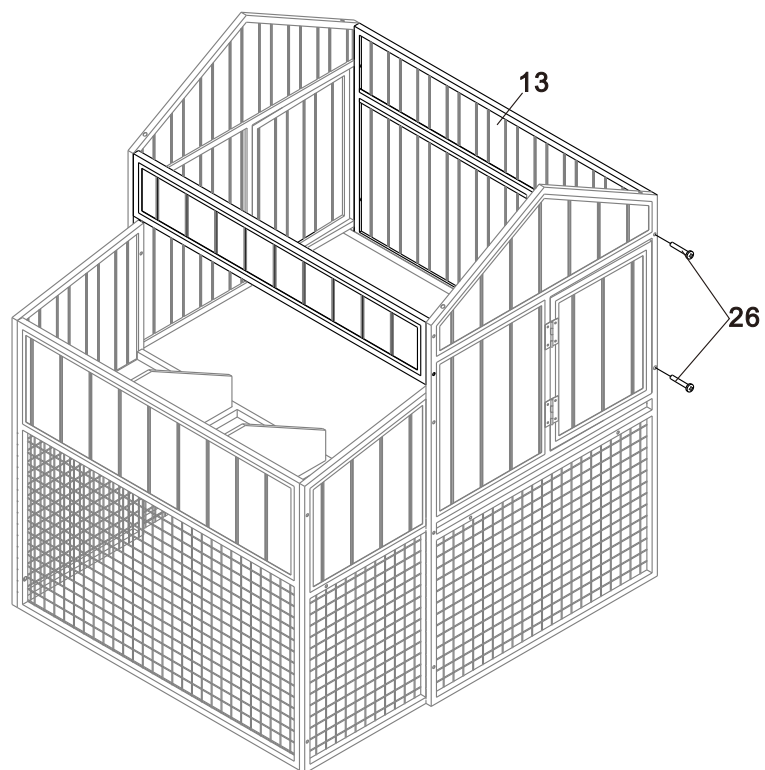

Step 11

- Attach the Nesting Box Roof Panel (#15) by Self-tapping Screw (#28).

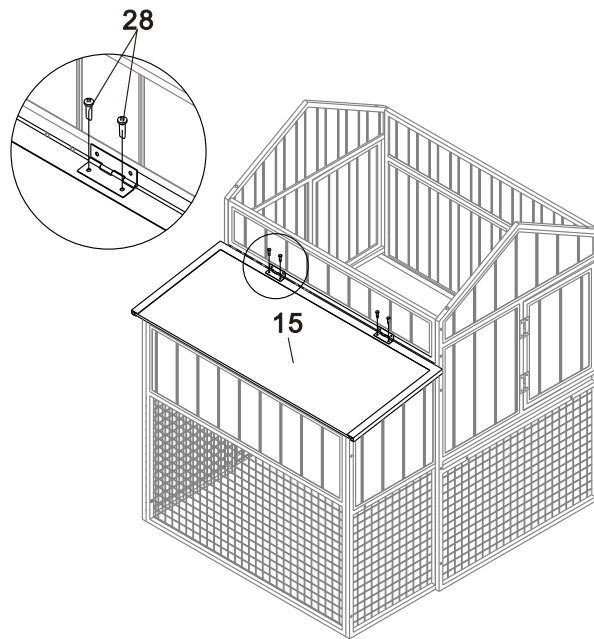

Step 12

- There is a Hinge Support pre-assembled on side of Nesting Box Left and Right Panel, now please fix its other end on the Nesting Box Roof by Tapping screw (#29).
- And assemble the Lock (#24) to the top center of the back panel (#1) by Tapping screw (#30) as below diagram.

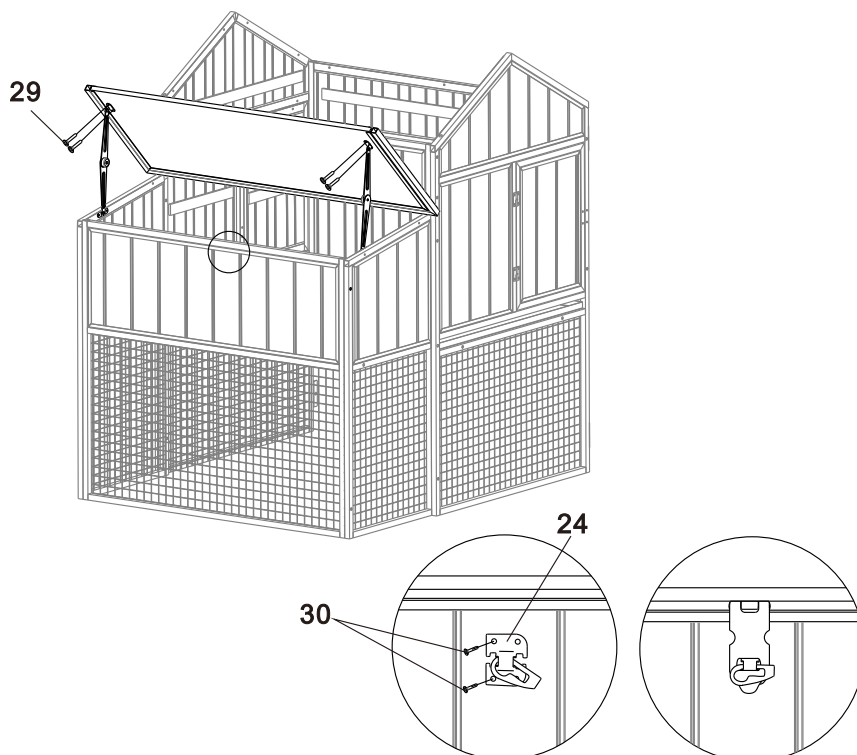

Step 13

- Attach the Coop Roof Panels (#16, 2pcs) with M6x30 bolts (#26) . And then fix the Roof Cap (#17) with #28 screws.

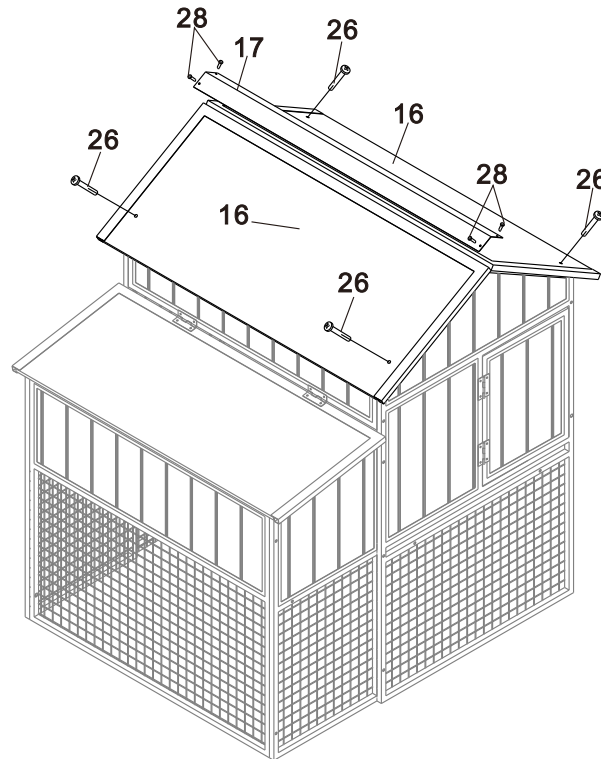

Step 14

- Fix the 2pcs Ramp Hooks (#18) to one end of the Ramp (#19) as below diagram.

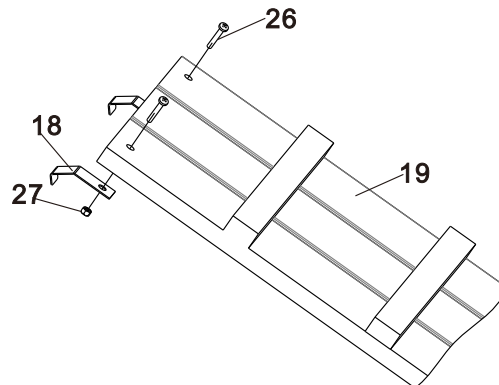

Step 15

- Hook the Ramp on the Coop Front Door.

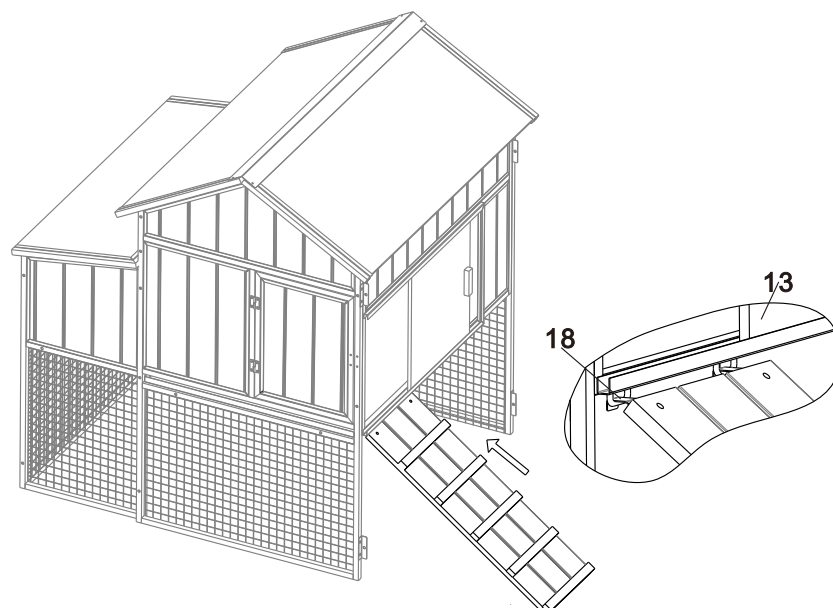

Step 16

- Now assemble the Pen Left and Right Panel (#20, #21) with Bolt M6x30 (#26) and Nut M6 (#27).

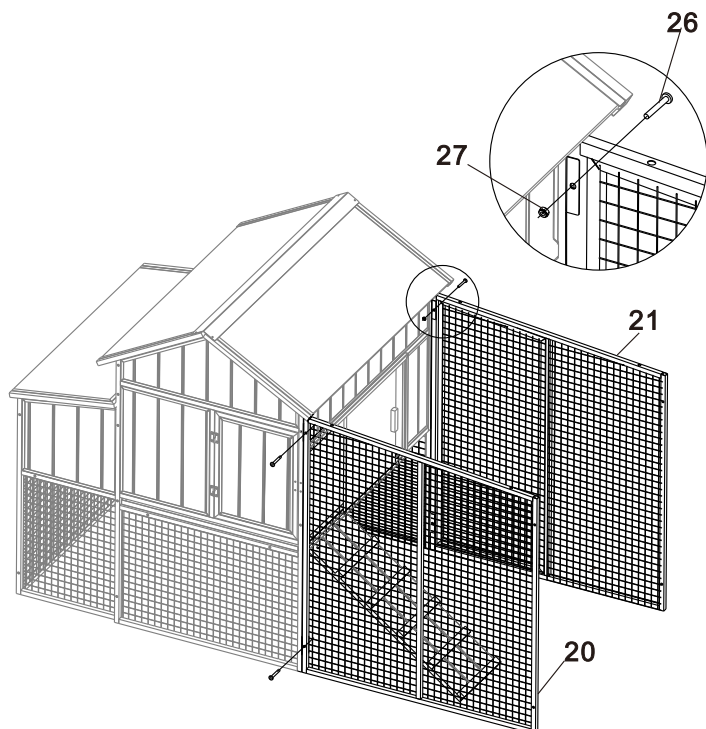

Step 17

- Then assemble the Pen Front Panel (#22) with Bolt M6x45 (#25) and Nut M6 (#27).

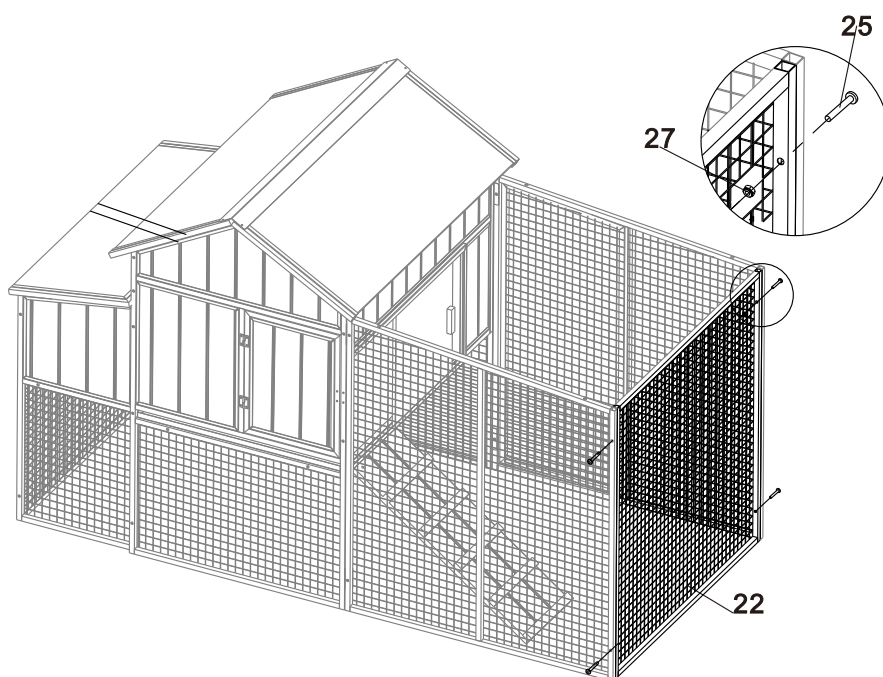

Step 18

- Please fix the Pen Roof (#23) by M6x30 Bolt (#26).

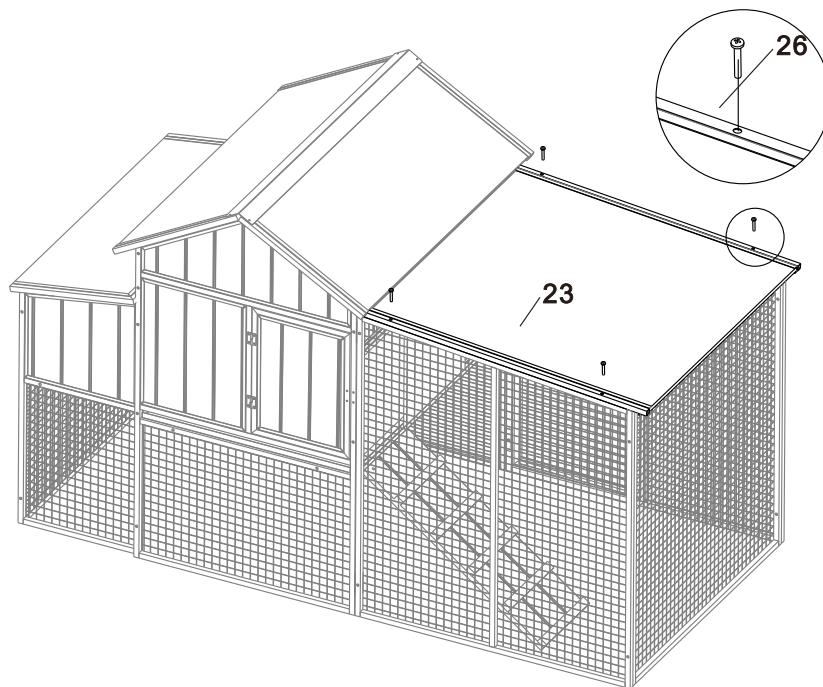

Step 19

- Finally, assemble the PVC Cover (#31) on top of the Coop Roosting Area Back Panel (#12) by Tapping Screw 3.5x13 (#29) as below diagram.

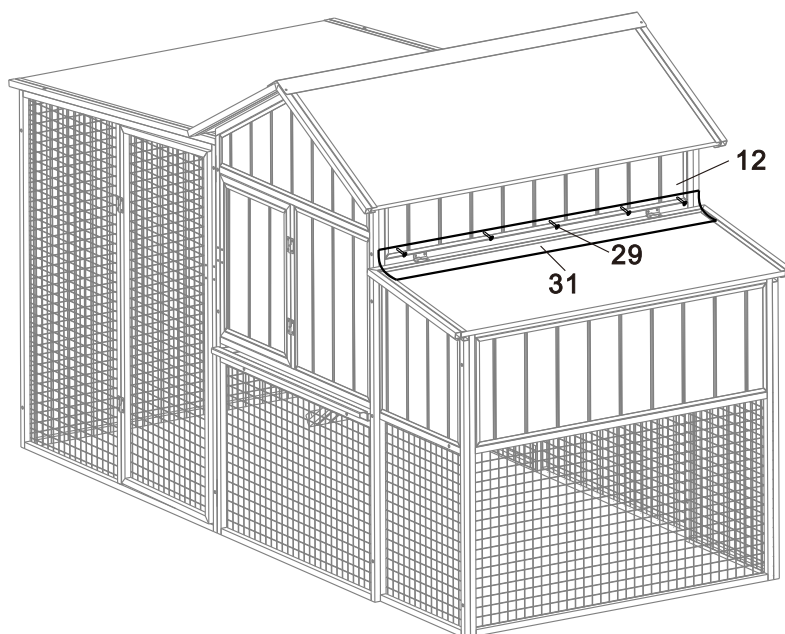

- The coop now is fully assembled and ready to use.