

#99081
Container Shelter
Model SS2620C 26'x20'x11'10"
W8.0xL6.0xH3.6m
(2m arch space)
Assembly Instructions



RECOMMENDED TOOLS



YOU MUST READ THIS DOCUMENT BEFORE YOU BEGIN TO ASSEMBLE THE SHELTER.

Thank you for purchasing our shelter. When properly assembled and maintained, this product will provide years of reliable service. These instructions include helpful hints and important information needed to safely assemble and properly maintain the shelter. Please read these instructions **before** you begin.

If you have any questions during the assembly, please contact local dealer for assistance.

SAFETY PRECAUTIONS

- . Wear eye protection.
- . Wear head protection
- . Wear gloves when handling metal tubes
- . Use a portable GFCI (Ground Fault Circuit Interrupter) when working with power tools and cords.
- . Do not climb on the shelter or framing during or after construction.
- . Do not occupy the shelter during high winds, tornadoes, or hurricanes.
- . Provide adequate ventilation if the structure is enclosed.
- . Do not store hazardous materials in the shelter.
- . Provide proper ingress and egress to prevent entrapment.

ANCHORING INSTRUCTIONS

Prior to assembling this shelter, please read the **MUST READ** document included with the shipment.

 **WARNING:** The anchor assembly is an integral part of the shelter construction. Improper anchoring may cause shelter instability and failure of the structure. Failing to anchor the shelter properly **will void the manufacturer's warranty** and may cause serious injury and damage.

LOCATION

Choosing the proper location is an important step before you begin to assemble the structure.

The following suggestions and precautions will help you determine whether your selected location is the best location.

- . Never erect the structure under power lines.
- . Identify whether underground cables and pipes are present **before** preparing the site or anchoring the structure.
- . Location should be away from structures that could cause snow to drift on or around the building
- . Do not position the shelter where large loads such as snow and ice, large tree branches, or other overhead obstacles could fall.
- . Your shelter's cover can be quickly removed and stored prior to severe weather conditions. If strong winds or severe weather is forecast in your area, we recommend removal of cover.

SITE

After choosing a location, proper preparation of the site is essential. The following site characteristics will help ensure the integrity of the structure.









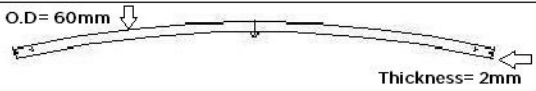
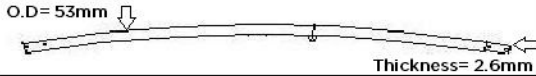
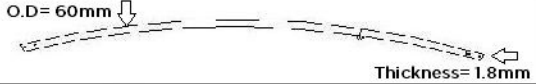
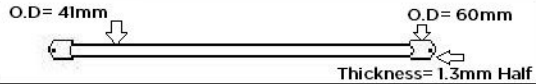

- . The support structure must be level to properly and safely erect and anchor the frame.
- . Drainage: Water draining off the structure and from areas surrounding the site should drain away from the site to prevent damage to the site, the structure, and contents of the structure.

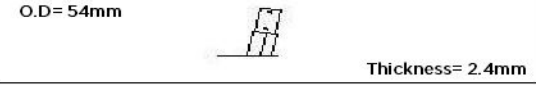
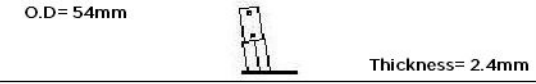
 **WARNING:** The individuals assembling this structure are responsible for designing and furnishing all temporary bracing, shoring and support needed during the assembly process. For safety reasons, those who are not familiar with recognized construction methods and techniques **must seek the help of a qualified contractor.**

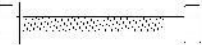
#99081

Single Truss Container Shelter

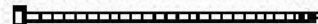
W8xL6xH3.6m (2m arch space) Parts List

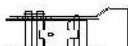
Part Code	Description	Qty
Roof		
1	Roof Bent Joist - Length= 2270mm	4
		
2	Middle Bent Joist - Length= 2000mm	8
		
3	Lower Bent Joist - Length= 2800mm	8
		
4	Purlin - Length= 2030mm	15
		
5	Support Tube - Length= 2435mm	12
		
6	Base Plate - Length= 25mm Squared	6
		
7	Base Plate - Length= 25mm Squared	2
		
8	Carriage Bolt M10x80 for purlin	20
		
9	Tube Clip with bolt M10x50 for support tube	24
		
10	Bolt M8x70 for swaged tube	48
		
11	Lower Tensioning Tube for Roof Cover, (2+1) pcs/set - O.D= 32mm Both Sets	2 sets
		
12	Roof Cover	1
		
13	Knitting Rope for roof cover (2 bundles)	1 set
		
14	Cable Tie for Roof Cover (on both ends)	40
		
15	Belt for Ratchet	14
		
16	Ratchet for tensioning of roof cover (four corners)	4
		

Framework Installation

Note: Please fix the container firmly before installing the shelter.

1. Weld base plates (No.6 & No.7) to the top of container. Please refer to the diagram (Figure 1) to mark the position of base plates.

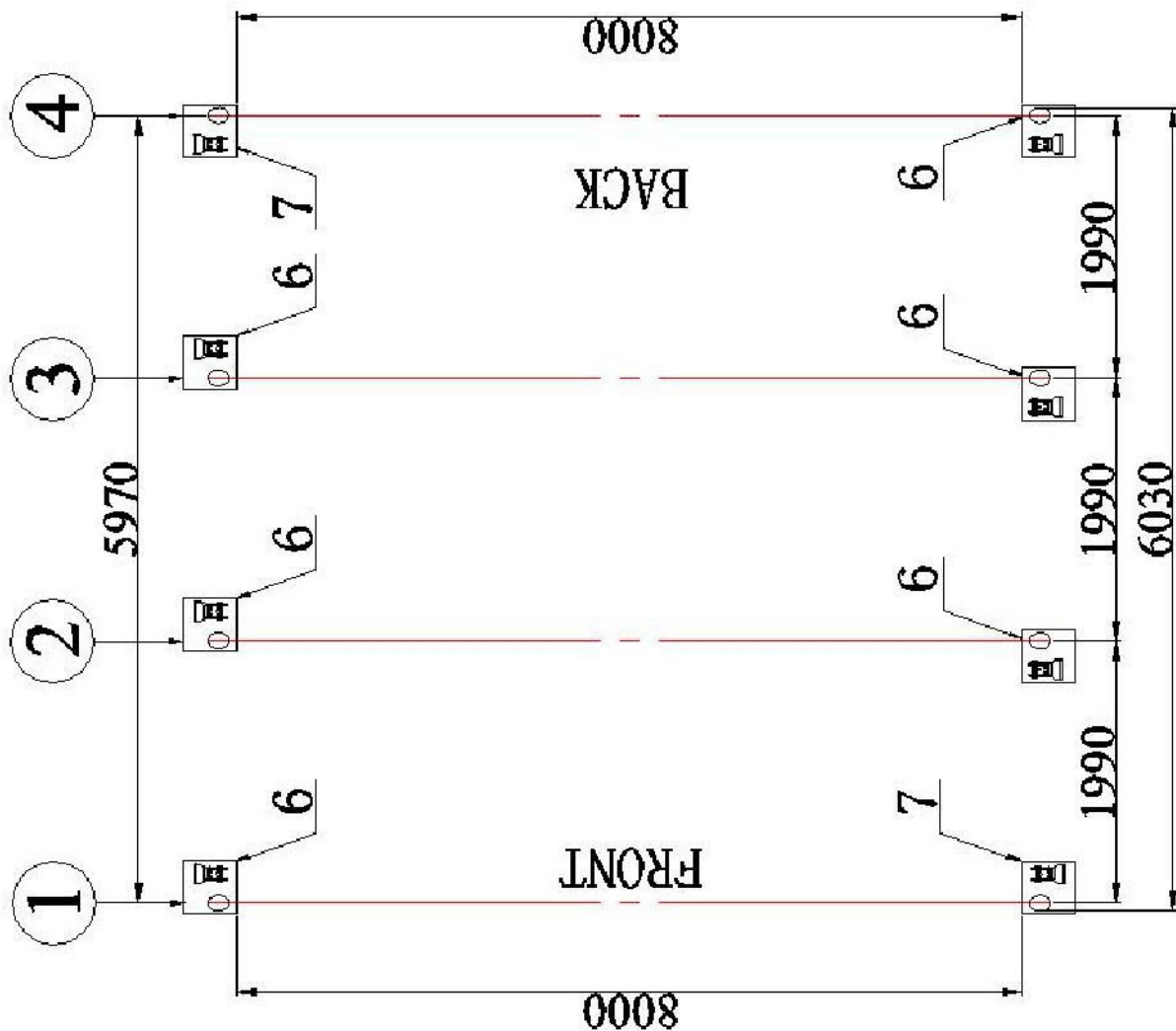
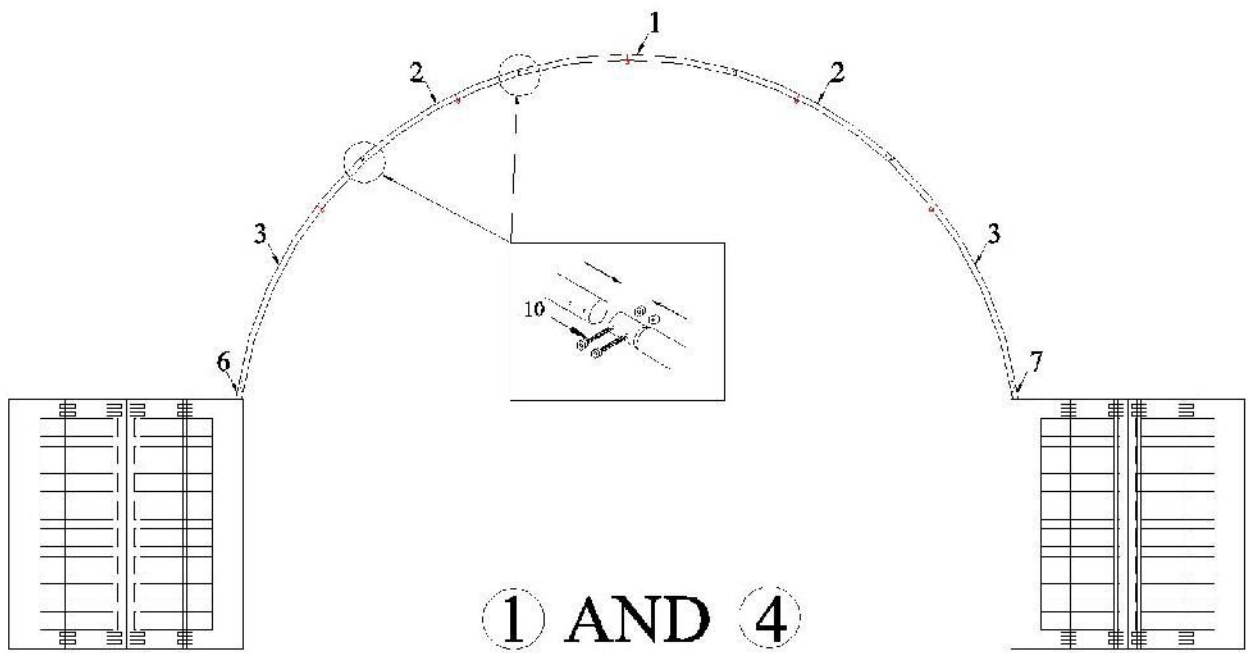

Figure 1

2. Connect the Bent Joist (No.1, 2, 3) by bolt M8x70 (No.10) to be one arch.
3. Put one end of the arch into the base plate (No.6 & No.7) and fasten it by bolt M8x70 (No.10), then try to put the other end into opposite base plate.
4. When 2 arches are in place, connect purlin (No.4) between them by carriage bolt M10x80 (No.8). Please note the direction of the bolt, do not leave the shaft outside where the fabric will rest. By this way, one arch and purlins between it in turn, frames are installed.
5. Install support tube (No.5) by Clip (No.9).

Note: Before install the arch, please install the clip first.

Arch No.1 & No.4



Arch No.2 & No.3

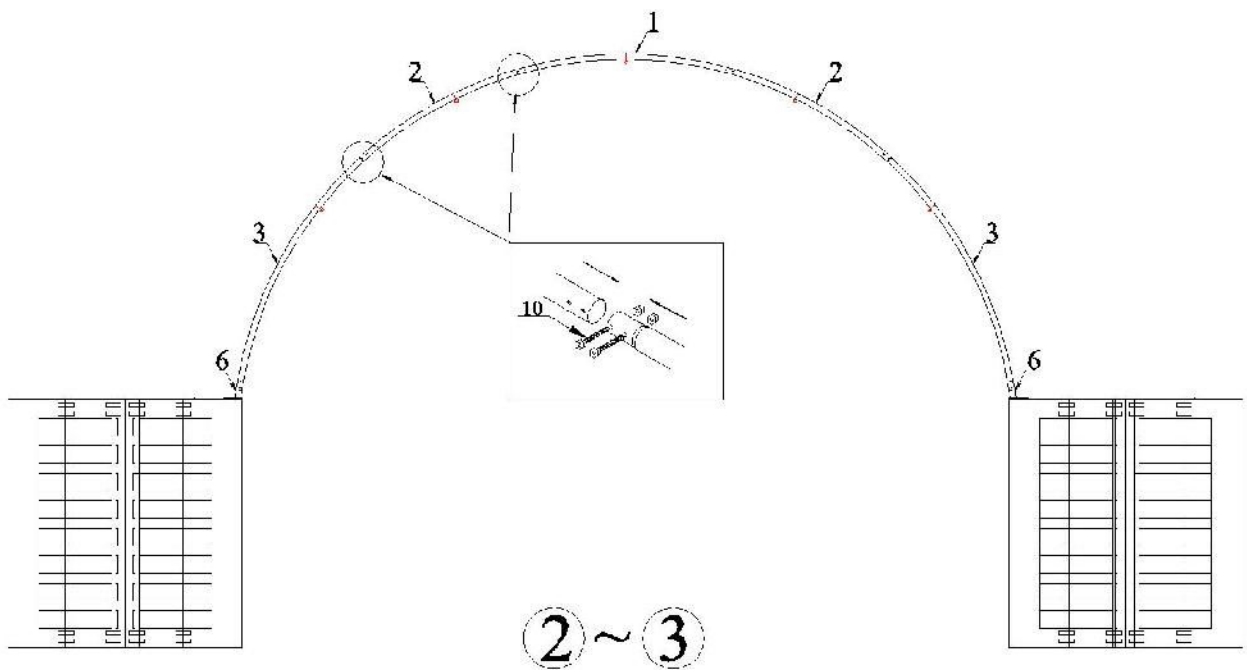

Purlins and Support Tubes

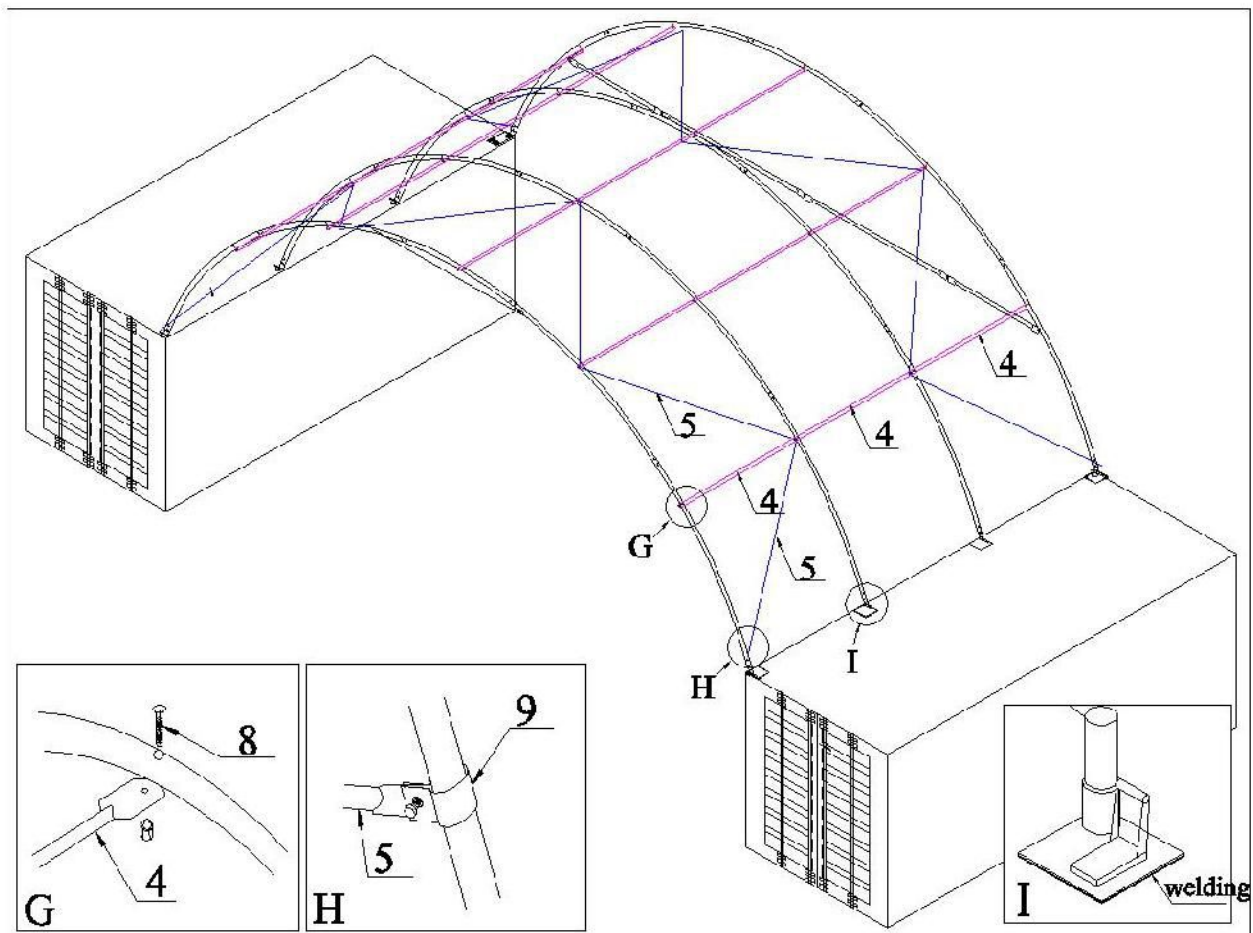

Cover Installation

1. Put the cover EVENLY, CAREFULLY AND SLOWLY on the frame. Insert the Tensioning Tubes (No.11) into the cover pipe pockets and loosely secure the Belt (No.15) in the ratchet on base plate. DO NOT TIGHTEN. Adjust the cover so that it is square and evenly centered on the frame.

Note: The end flaps must overhang evenly at both ends.

2. First use Cable Tie (No.14) to fix the two ends of roof cover to end arches at intervals. Then use Rope (No.13) to tighten roof cover to end arches. The rope should be cut as your requirements when using. When the cover is tidy and ready, drive the ratchet tie down forth and back and then roof cover is tightened. Pull the band inside the roof cover (four corners) by Ratchet (No.16). The ratchets need to be welded to container.

Note: DO NOT LEAVE COVER UNATTACHED UNDER ANY CIRCUMSTANCES until the final assembly and tightening has been completed.

The process is quite easy. But some tightening adjustments will be necessary to produce a flat, tensioned roof cover.

Roof Cover

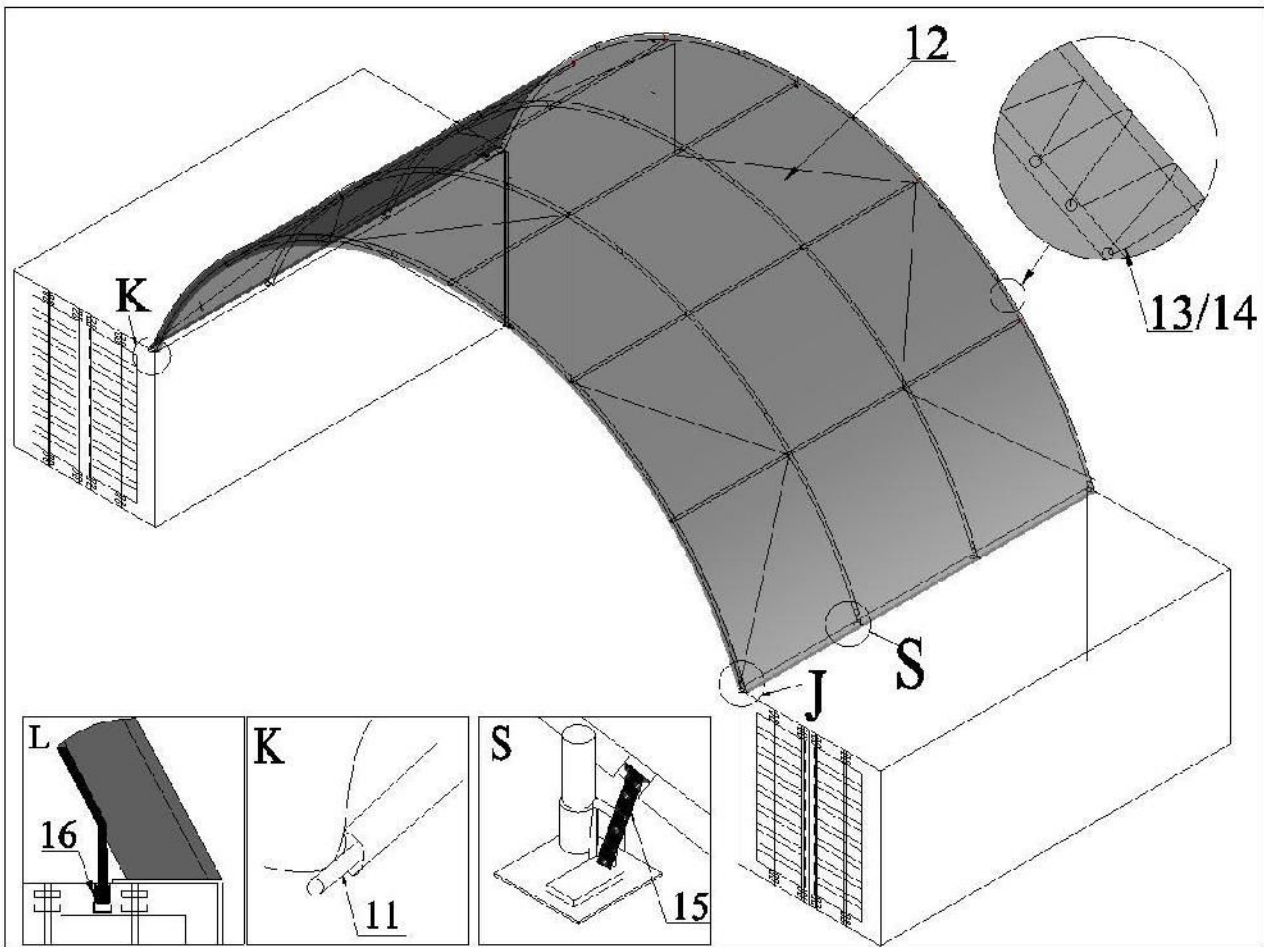

Now your installation is completed.